

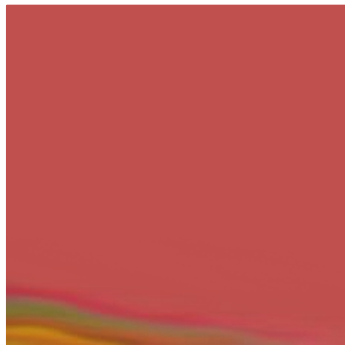

Centro E. Piaggio
bioengineering and robotics research center

Inkjet Printing

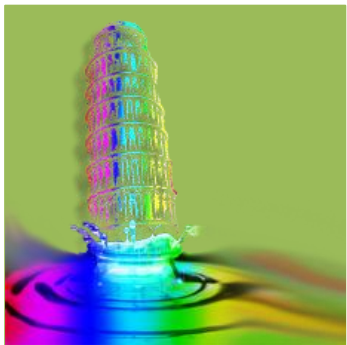
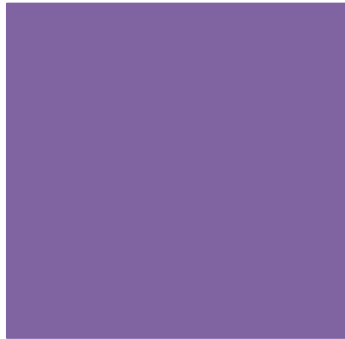

carmelo.demaria@centropiaggio.unipi.it

PRINTABILITY OF INKS

+ Printability of inks

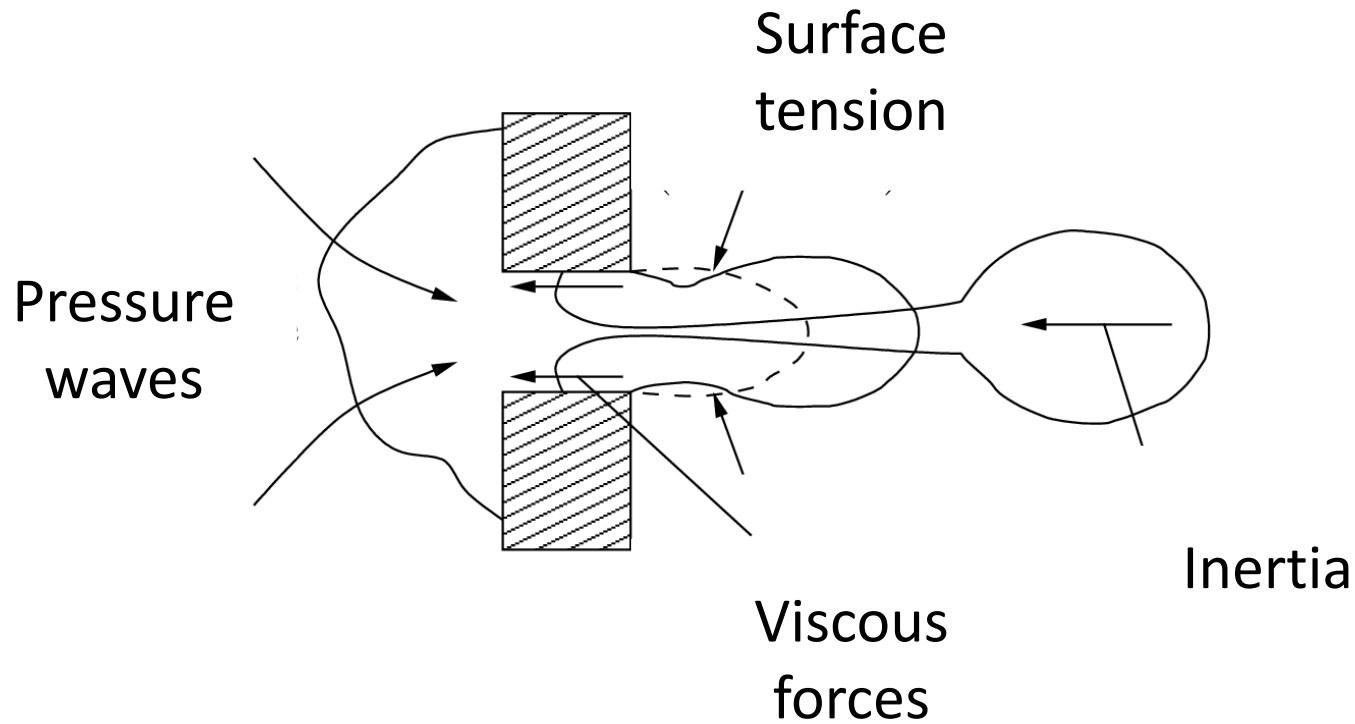

+ Adimensional analysis

$$Re = \frac{v r a}{h} = \frac{\text{inertial forces}}{\text{viscous forces}}$$

$$We = \frac{v^2 r a}{g} = \frac{\text{inertial forces}}{\text{surface forces}}$$

$$Oh = \frac{\sqrt{We}}{Re} = \frac{\text{viscous forces}}{\text{surface forces}}$$

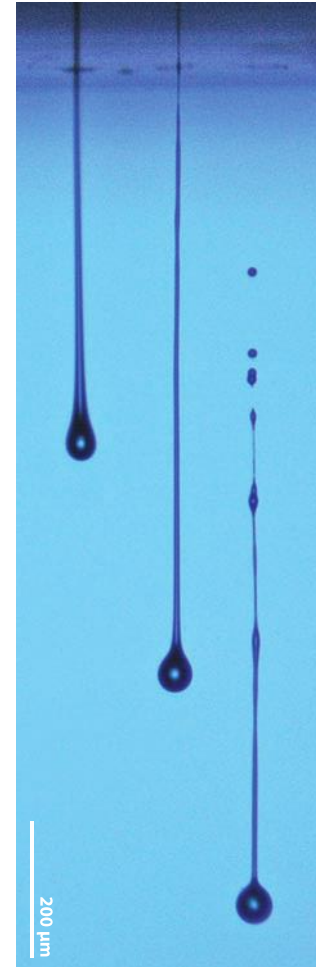

+ Physics of drops: ejection

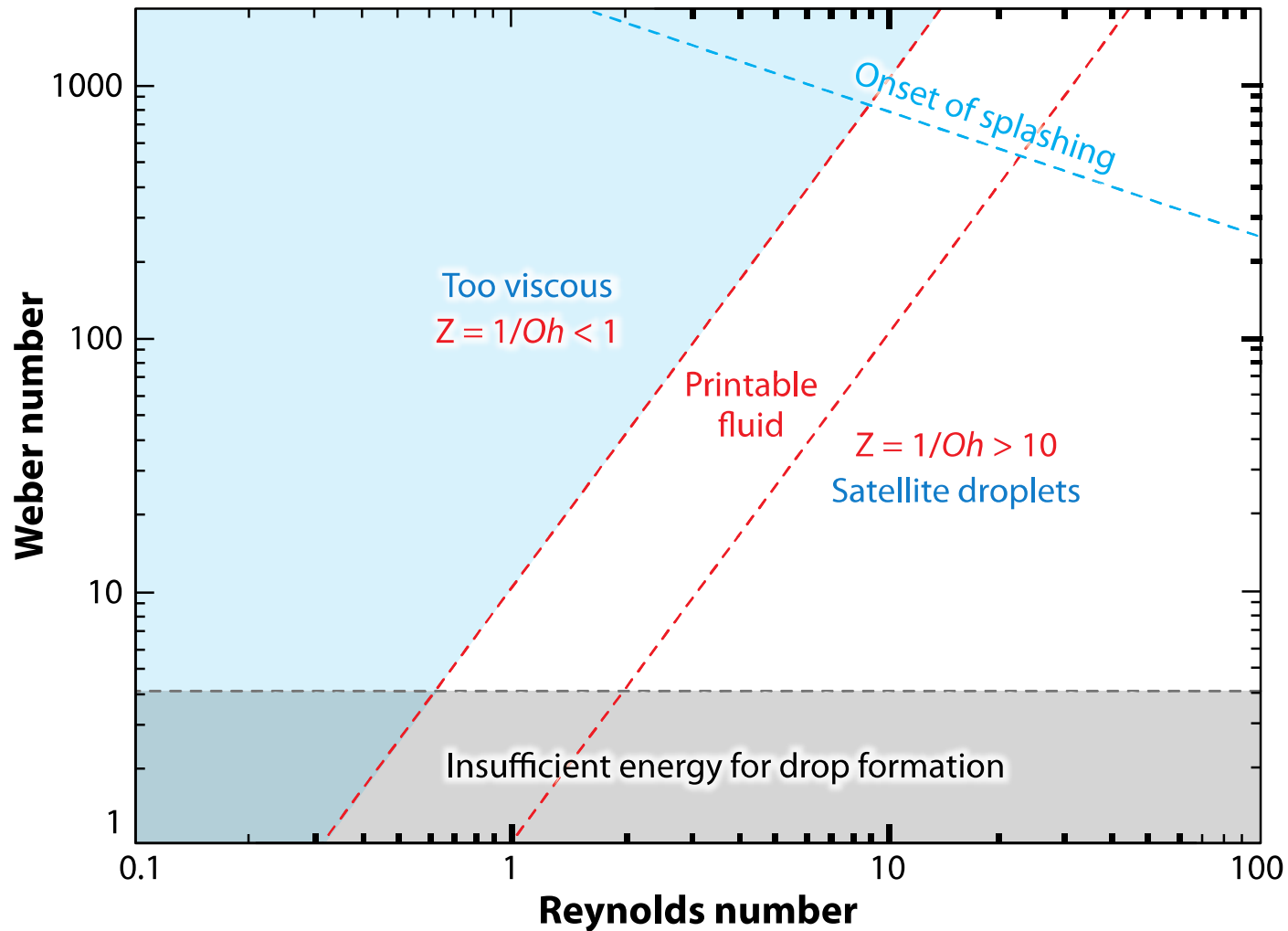

+ Physics of drops: ejection

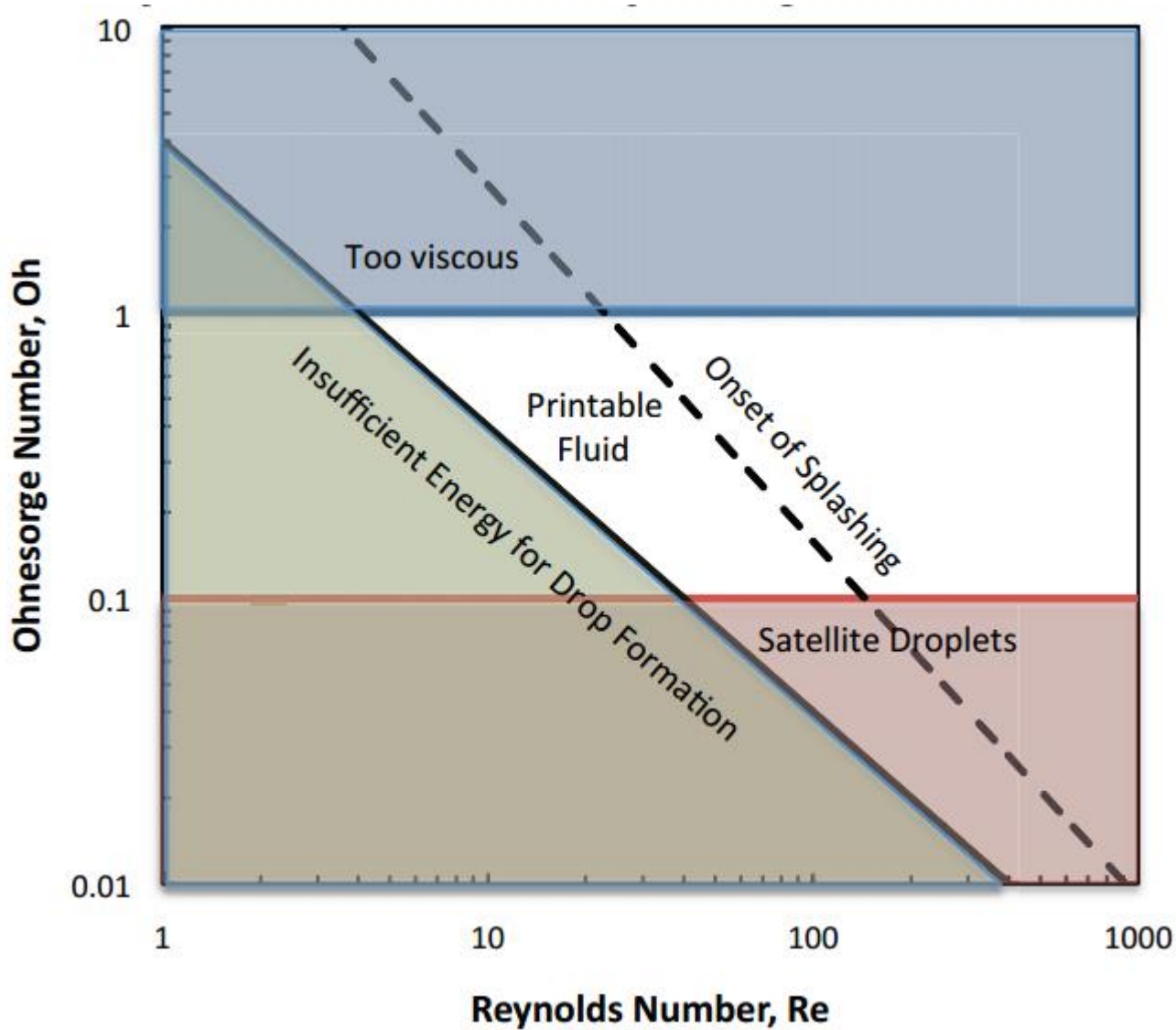

+ Physics of drops: impact

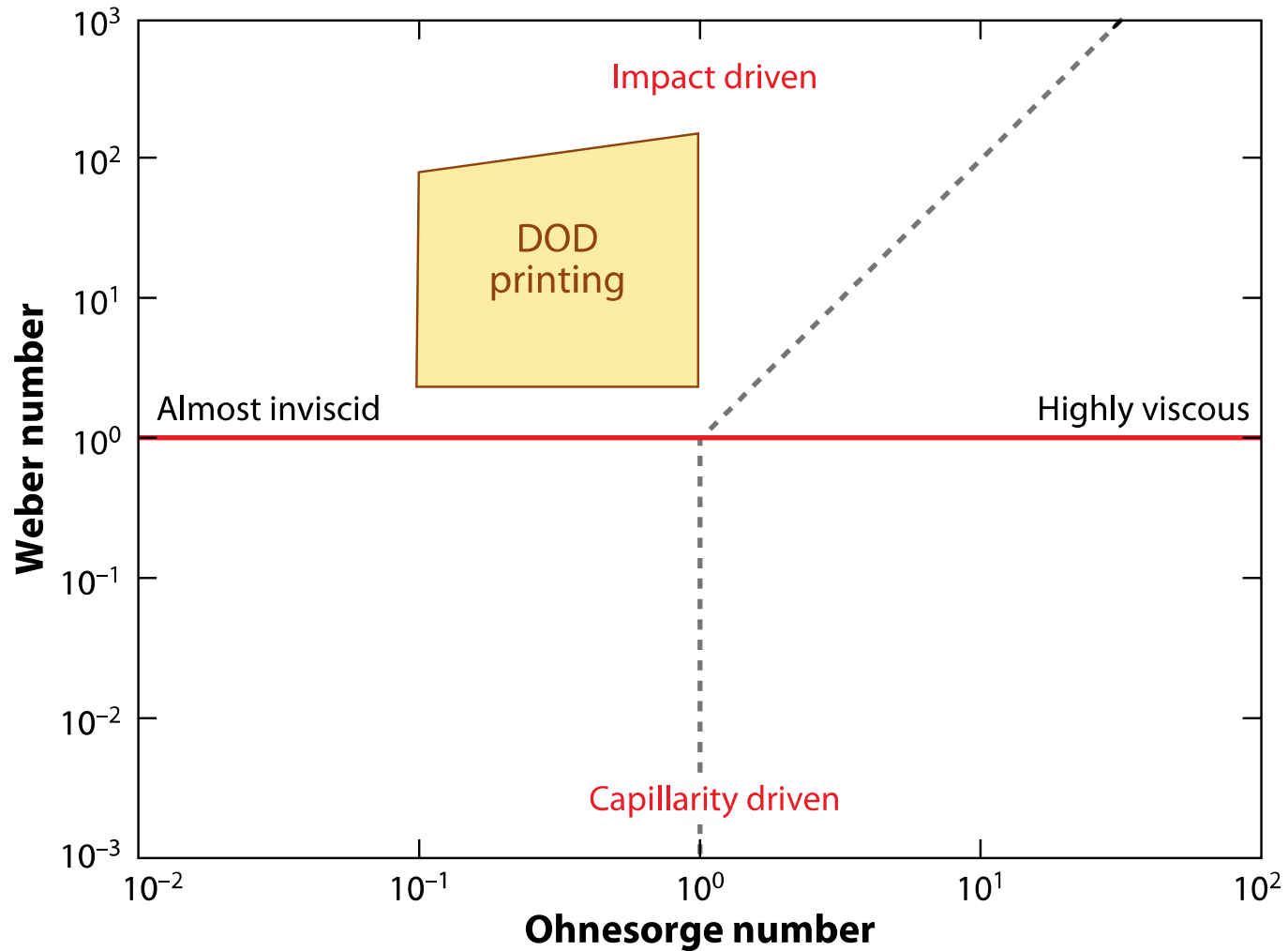

+ Physics of drops: impact

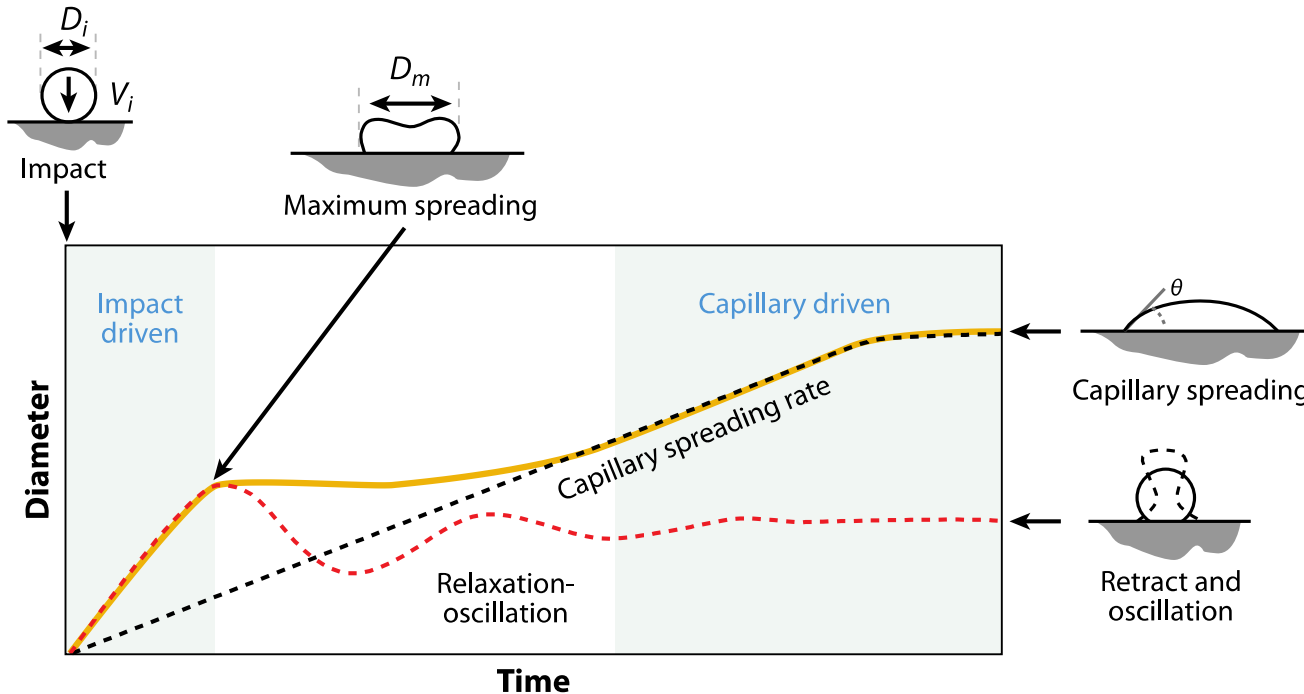

- The final diameter is a linear function D_i
- The drop footprint increases with decreasing the contact angle and is about $3D_i$ at a contact angle of 10°
- Coffee ring effect

+ Coffee ring effect 1/2



+ Coffee ring effect 2/2

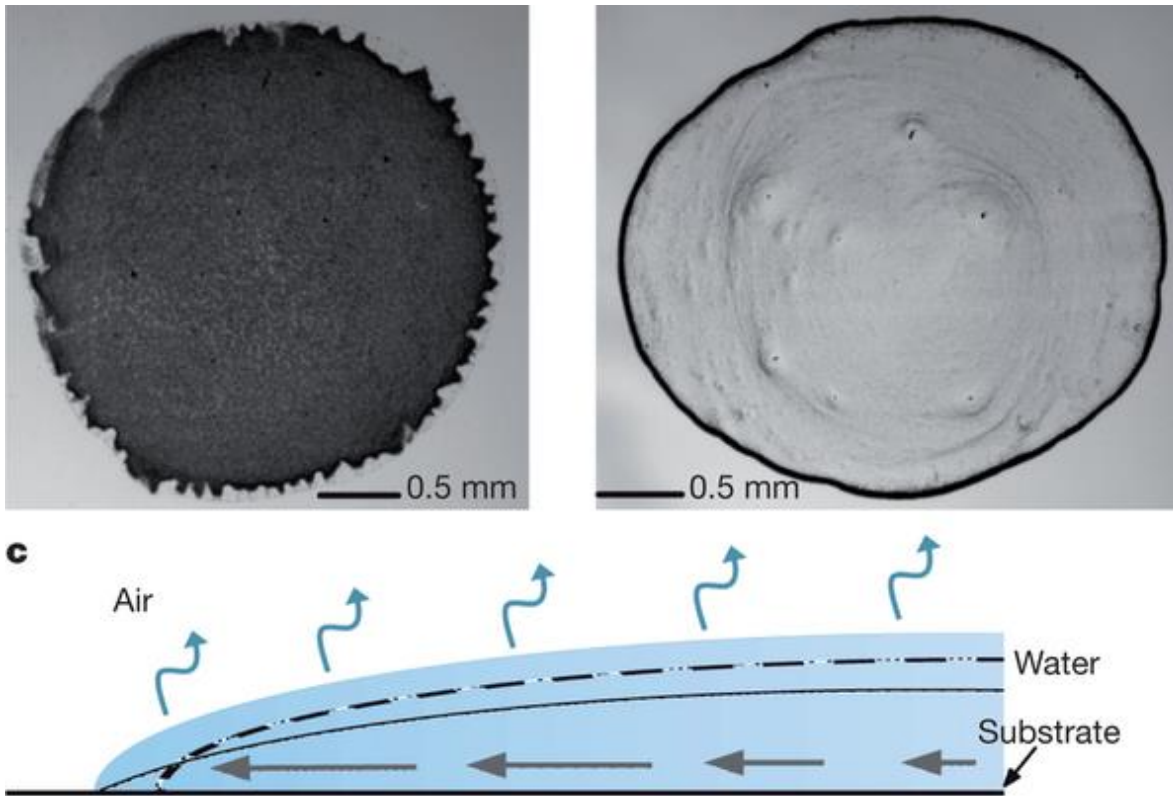

+ Physics of drop: line formation

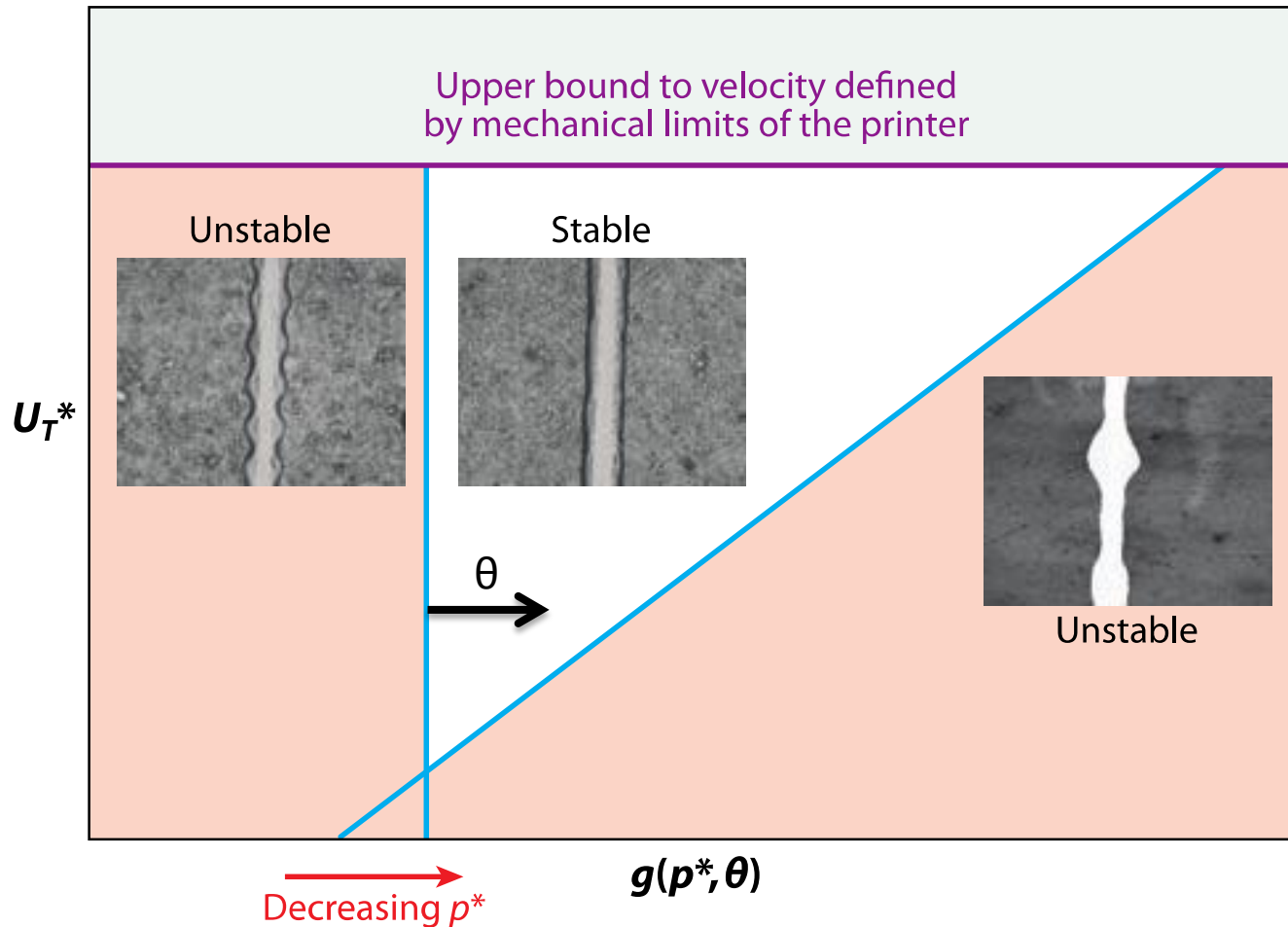

+ Types of ink

- Water based ink (from 60-90 %)
 - Viscosity range $2 - 8 \cdot 10^{-3} \text{ Pa s}$
- Solid ink (hot melt or phase change)
 - Often based on wax
 - Viscosity $8-15 \cdot 10^{-2} \text{ Pa s}$
 - Temperatures $120-140^\circ\text{C}$
 - Nozzle of printhead ejects hot melt
 - Instantaneous solidification upon contact avoids spreading
- Oil-based ink
- UV-curable inks

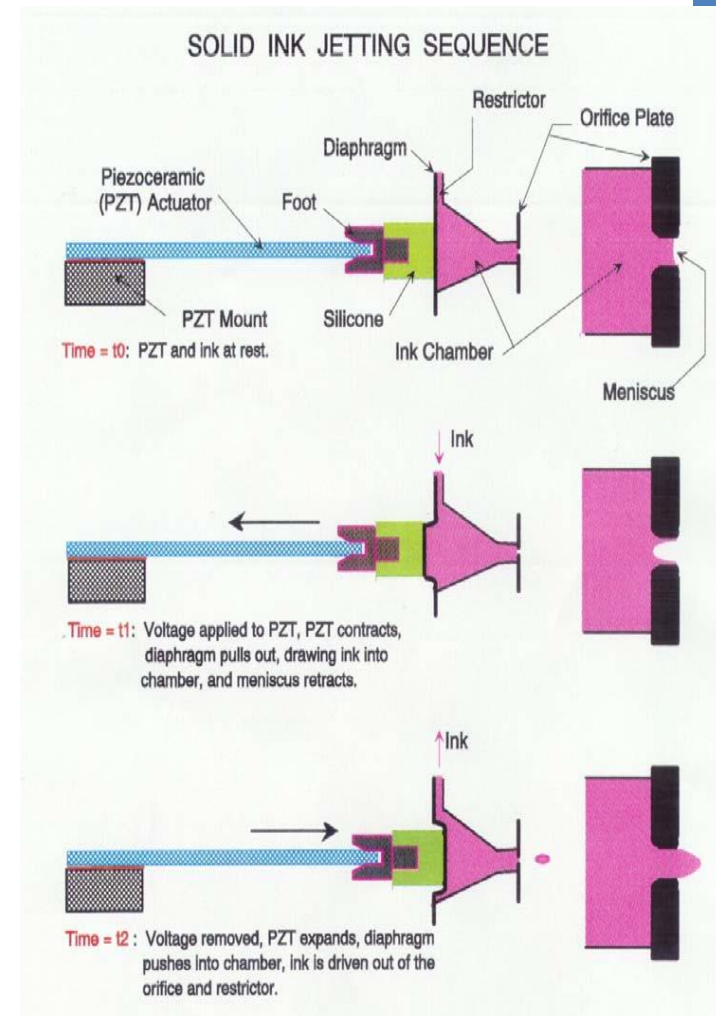



WHAT ABOUT 3D?

+ 3D-Generative manufacturing processes

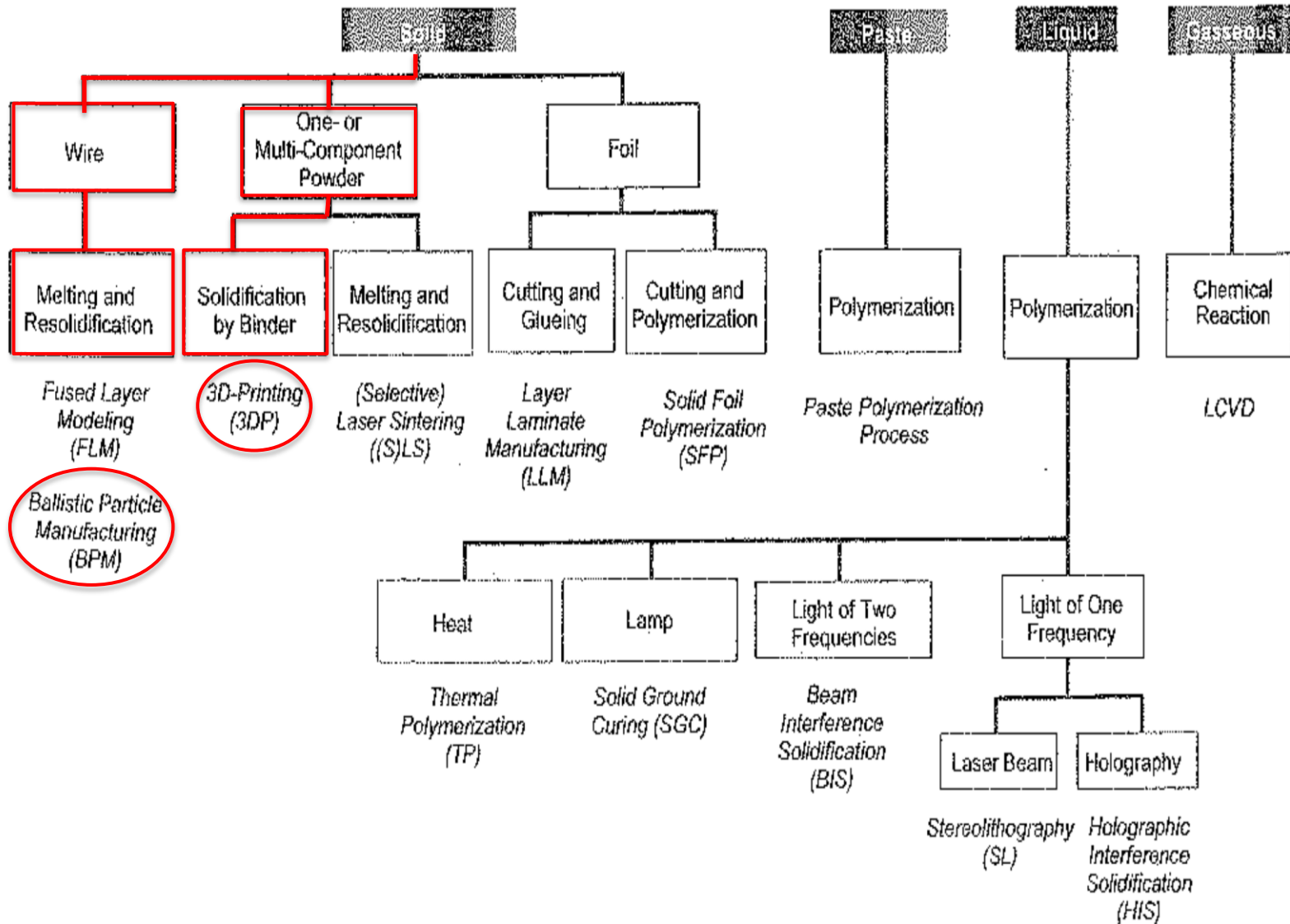

+ Additive manufacturing process using ink-jet approach

- Stereolithography – Polyjet
 - Liquid photopolymer
- Multijet Modeling
 - Wax like ink
- Three dimensional printing (3DP)
 - Printing a binding agent onto a powder
 - Conglutination of granules and binders



+ PolyJet

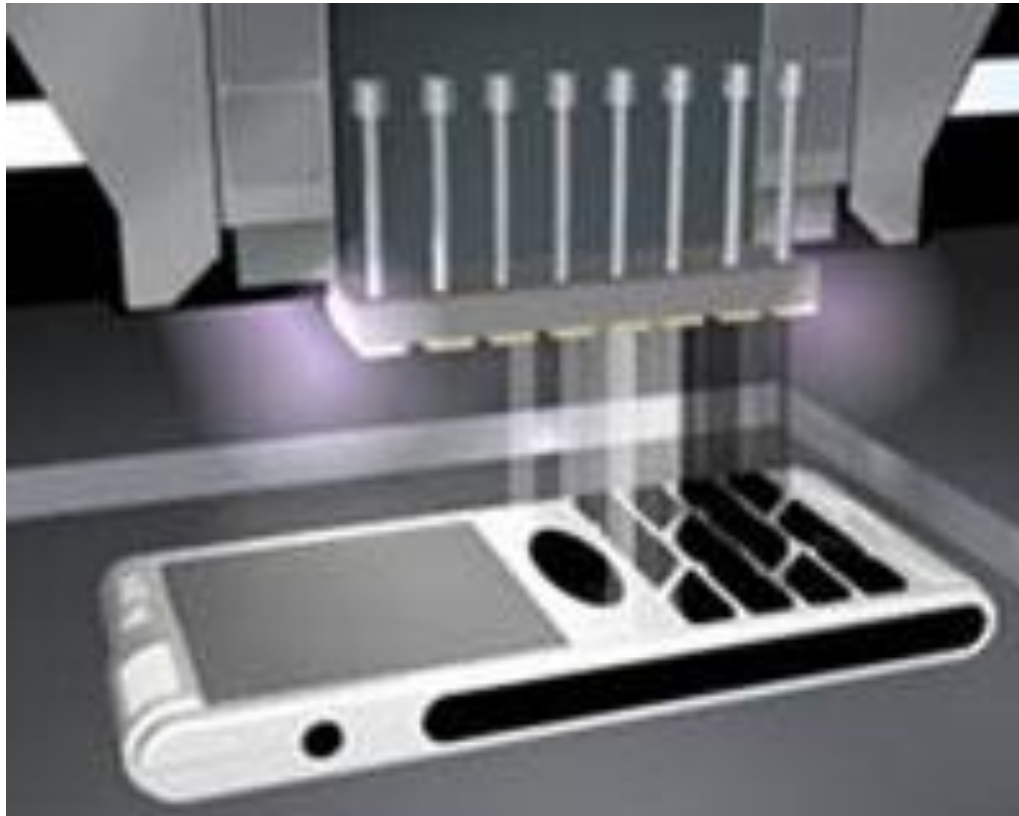

+ Polyjet – Object 30 Pro



3D PRINTER SPECIFICATIONS	
Model Materials	Rigid Opaque: VeroWhitePlus™, VeroBlackPlus™, VeroGray™, VeroBlue™ Transparent: VeroClear™ Simulated Polypropylene: Rigur™ and Durus™ High Temperature
Support Material	SUP705 gel-like photopolymer support
Maximum Build Size (XYZ)	294 x 192 x 148.6 mm (11.57 x 7.55 x 5.85 in.)
System Size and Weight	82.8 x 80 x 62 cm (32.5 x 23.6 x 24.4 in.); 106 kg (234 lbs.)
Resolution	X-axis: 600 dpi; Y-axis: 600 dpi; Z-axis: 900 dpi
Accuracy	0.1 mm (0.0039 in.) varies depending on part geometry, size, orientation, material and post-processing method
Minimum Layer Thickness	28 microns (0.0011 in.); 18 microns for VeroClear material (.0006 in.)
Build Modes	High quality: 18-micron (.0006 in.) resolution High speed: 30-micron (.001 in.) resolution
Software	Objet Studio™ intuitive 3D printing software
Workstation Compatibility	Windows XP/Windows 7/Windows 8
Network Connectivity	Ethernet TCP/IP 10/100 base T
Operating Conditions	Temperature 18-25°C (64-77°F); relative humidity 30-70%
Power Requirements	Single phase: 100-120V; 50-60Hz; 7A or 200-240V; 50-60Hz 3.5A
Regulatory Compliance	CE, FCC/RoHS



+ Depositing building material

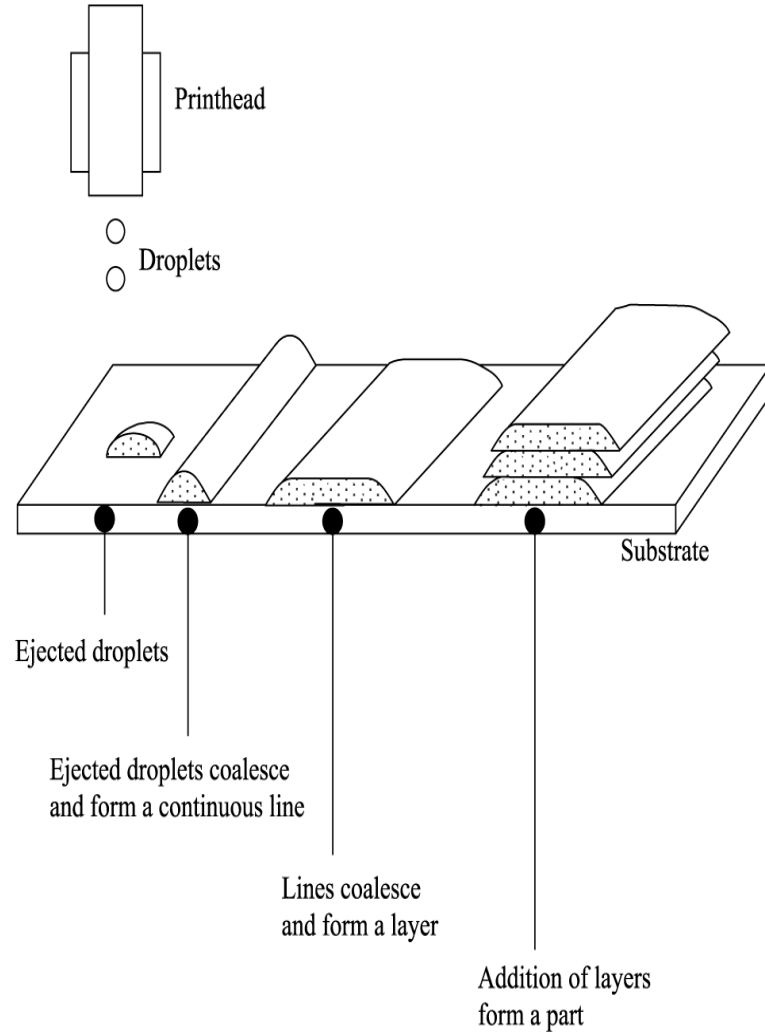

+ Model Maker

- **Short description:** prototyper (Modelmaker II) and prototyping system (Patternmaster) for production of small, very precise models and prototypes. One print head applies molten hard waxlike material drop by drop while a second applies low-melting wax that acts as a support material. Each layer is milled resulting in very precise models that are especially well suited for the precision casting of precision parts
- **Development state:** commercialized since 1994
- **The principles of layer generation:** the heated inkjet print head contains molten material that is shot as micro droplets onto the model structure. The drops solidify into the model as a result of heat conduction. The impact energy deforms the drop so that the applied material tracks have a height/width ratio of approx. 0.6:1. Layers as thin as 0.013 mm can be realised. Those areas that are not part of the model are filled by a second print head with low melting wax that serves as support material. The surface is milled plano after each layer application so that high accuracy is achieved also in the z-direction. It is not necessary to cool the material.
- **System Type/Construction:** the machine consists of a build platform over which the two print heads traverse in the x-y direction (position accuracy 0.006 mm). On the same x-axis a cylindrical milling cutter is attached that is connected to an extraction system. The build platform can be positioned very accurately in the z-direction (0.0032 mm). The usable built chamber is x, y, z = 304.8 * 152.4 * 228.6 mm. The print head emits droplets of molten material with a diameter of approx 0.0075 mm that are applied in a straight line generating a land of approx 0.010 mm width and 0.006 mm height. Such a line structure can be generated with a speed of 30.5 mm/s (which is the equivalent of an application of approx. 0.11 mm³/min).
- **Material/Built Time/Accuracy:** the proprietary materials are hard wax blends. The building is done by a green thermoplastic material, called ProtoBuild. The red support material called ProtoSupport consists of natural and synthetic waxes and fatty esters. The building material has a much higher melting point (90°-113°C) than the support material (54°-76°C). The material shows no shrinkage, it is non toxic. The built takes a relatively long time that can be shortened if the layer thickness is increased up to a maximum of 0.13 mm; this, however, impairs the definition. The accuracy is specified at 0.025 mm over 76 mm, half of each trip (or ¼ of the construction plane) in the x-y plane and with 0.013 mm on the entire z-length of 229mm (influence of the milling).
- **Post-processing:** the supports are removed with a solvent. Further post-processing is in general not necessary.

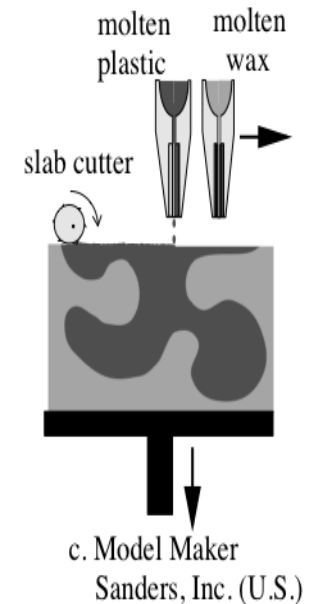

+ MultiJet Modeling

- **Short description:** thermojet is a 3D printer with several piezoelectrical print heads arrange in line. It was realised for fast and uncomplicated production of design models constructed of a thermoplastic similar to hard wax, and as a 3D network printer.
- **Development state:** commercialized, marked introduction in early 1999
- **The principles of layer generation:** small drops of waxlike thermoplastic are applied in layers by means of multiple print heads arranged in a line and functioning on the piezoelectric principle. The print head has 352 nozzles arranged in the y-direction so that, per layer, the build platform need only to be traversed once in the x-direction. The supports are generated at the same time as thin needles of the same material and are easily broken off manually when the model is finished.
- **System Type/Construction:** the thermojet prototyper has the dimensions of a larger office photocopy machine machine. The build chamber is x, y, z = 250 * 190 * 200 mm. The built progress can be observed through a large window.
- **Material/ Built Time/Accuracy:** the currently used material is called Thermojet 88 a thermopolymer on paraffin basis available in white, black or gray. The material is put into the machine in cartridges of 2.3 kg. The maximum definition is 400 dpi in the x-direction and 300 dpi in the y direction.
- **Post-processing:** after the build process only the needle-like supports need removing from the model. This can be done by hand

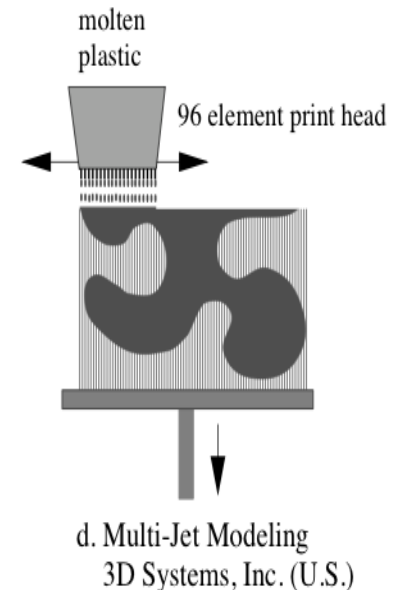

+ 3DP – why it works?

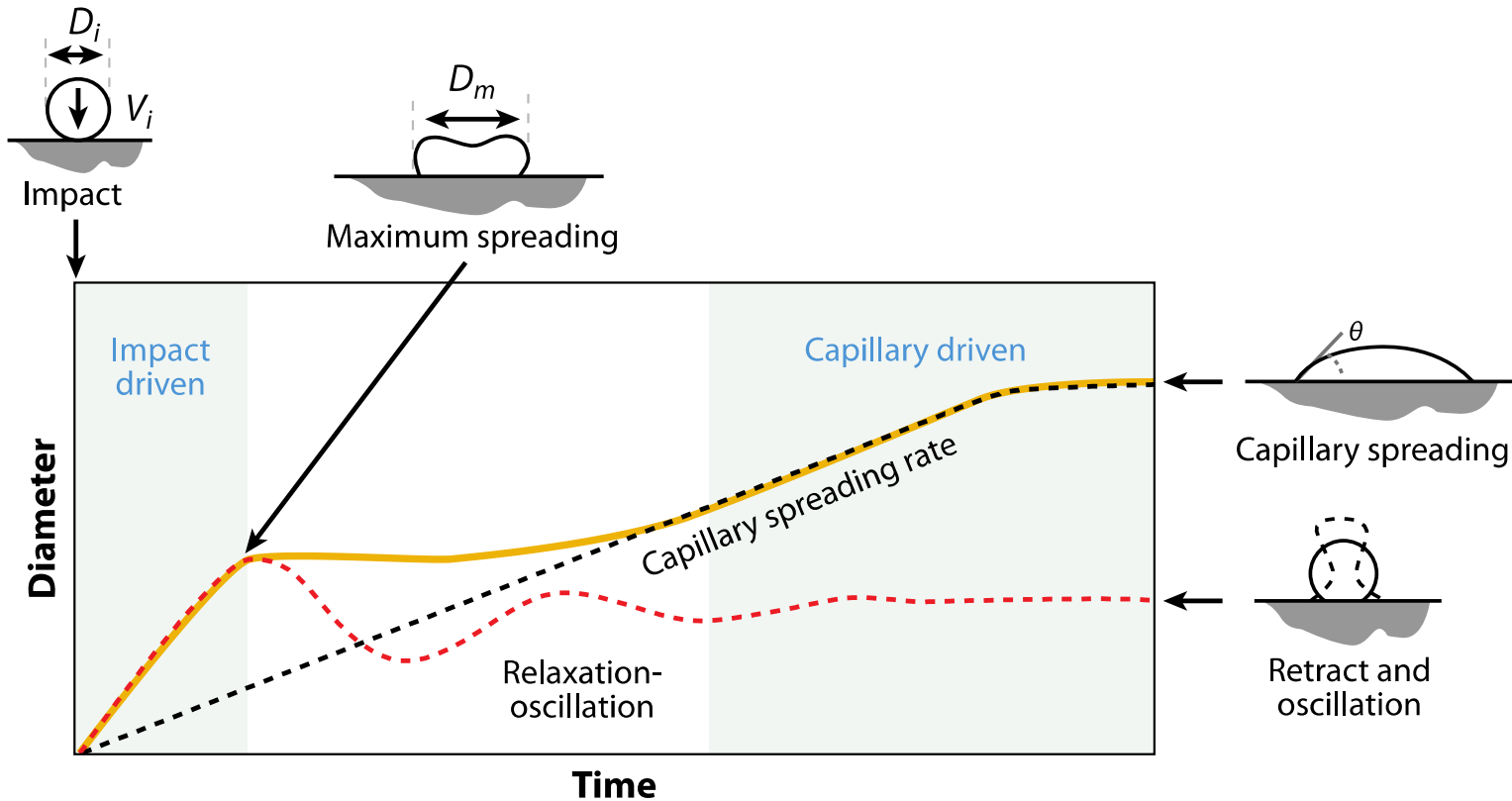

- The characteristic time of chemical reaction is bigger than capillary spreading, so the drop has the time to spread before reacting

+ 3DP

- **Short description:** a machine family for the production of solid images using the MIT 3D printing process in which a water-based liquid is injected into starch powder. The process is trimmed for speed and for the simplest of handling. The degree of detail reproduction is low, without a special infiltration the models are not resistant to mechanical stress, and the material is environmentally acceptable.
- **Development state:** commercialized as Z402 Concept Modeler since 1998.
- **The principle of layer generation:** a colored, water-based liquid is injected into a powder bed of cellulose powder by means of an inkjet print head resulting in local solidification and thereby generating the elements of new layer and joining it with the preceding one. Powder that is not wetted stays in the build chamber and supports the model. The models must be infiltrated with wax or epoxy resin, as otherwise they are not resistant to mechanical stress.
- **System type/construction:** the machine consist of a build envelop with three chamber above which a coating and plotter mechanism is installed. Two chambers, the powder supply container and the actual build chamber, have movable bases. The base of supply cylinder is raised, and a distribution roller takes up a certain amount of powder and, moving across the build chamber, distributes it evenly. Surplus powder passes to the overflow container. The recoating process takes only few seconds. The print head works like an inkjet printer with 128 parallel nozzles. The liquid accounts for about 10% of the model volume.
- **Material/Build time/Accuracy:** the powder is basically starch – chemical terms a polymer of D-glucose. By injection of a liquid it becomes locally firmly linked. The material can be stored and processed easily, and the disposal of the material is considered to be problem-free. Color is obtained either by one multi color single printheads (CANON type, Z402C) or by six single color printheads (HP type, Z406, Z806). A large number of powder-binder combination can be used. The machine is very fast building, 5 to 10 times faster than other prototypers. Facilitating the speed is a very fast slice process. The coating takes only a few seconds and is also very fast. The print head passes over only those cetion of the build chamber that contain a model. Thereby the build time is optimized. Because the print head always passes over the entire area of the above mentioned section, the build time is not influenced by the complexity of the geometry. The definition in the x-y plane is 600 dpi. There is the additional effect of particles, which really lie outside the countour, being “glued on” by capillary activity and, similar to the sinter process, have the appearance of a “fleece”. The models are therefore relatively inaccurate, with a rough surface and a porous structure but suitable for “show and tell” applications.
- **Post-processing:** the models are taken out of the powder bed after the process and the supporting powder is simply removed by vacuum cleaner. Slight sand blasting is of advantage.

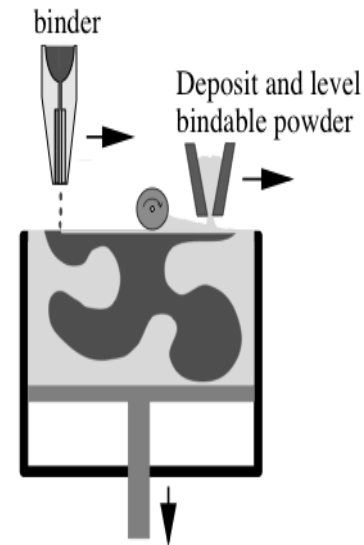

a. Three Dimensional Printing
MIT, and Soligen, Inc. (U.S.)



+ 3DP - Rapid Tooling System

- **Short description:** the rapid tooling system 300 (RTS 300) is a prototyper for the production of functional components, molds, and tools made of steel powder using the 3DP process (license held by MIT). A “green part” is generated in the machine. After the build process the binder must be removed and the component infiltrated with metal.
- **Development state:** commercialized since 1997
- **The principle of Layer generation:** the components are generated layer by layer by injecting liquid binder through a print head onto the surface of the powder bed. In the machine a model, called “green part”, is generated. It does not derive its stability from thermal fusion as in the sinter process but by injection of a binder into the metal or ceramic powder. The advantage, in contrast to the sintering of multicomponent metal powders, is that, owing to the separation of the construction material and the binder, a segregation in the powder is ruled out. In addition the process in the machine runs almost “cold”. The binder at first only makes the particles stick together. By exposure to high-energy lamp the layer is dried and solidified so that a transportable “green part” is generated.
- **System Type/Construction:** the stable machine (weight approx. 3.5t) has a base frame that serves as a portal. In addition to the print head, a lamp is also fitted to the portal that serves as a heat source mainly for drying the binder. The maximum size of component is $x, y, z = 300 * 300 * 250$ mm
- **Material/ Build Time/Accuracy:** Materials are stainless steel powder and ceramic powder.
- **Post-processing:** the green part is solidified outside the machine by thoroughly burning the polymeric binder. Afterwards, the porosities are infiltrated by low-melting (copper-based) metal alloys. The surface must be reworked mechanically.

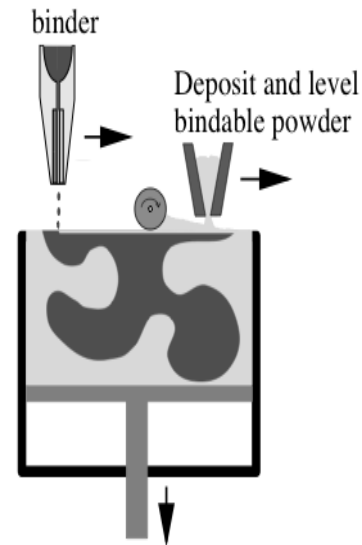

a. Three Dimensional Printing
MIT, and Soligen, Inc. (U.S.)



Direct Shell Production Casting



- **Short description:** processes and prototypes based on the 3D printing process producing ceramic moulds for precision casting by injecting liquid binder into ceramic powder. Machine to produce ceramic moulds directly for precision casting processes.
- **Development state:** commercialized since 1993. Now the company works as a service bureau.
- **Data formats/software:** the machine requires CAD data via neutral interfaces as the basis for the optimization of foundry technology. The producer-supplied software generates one-piece mold on the basis of the CAD data for the required mold model, while observing all the technical rules of casting.
- **The principles of layer generation:** first the powder feeder applies a thin layer (0.12 to 0.18 mm) of aluminium powder (corundum) on the build plane. To do this a portal above the build chamber is traversed that helps to distribute the powder evenly over the build plane. With the aid of a roller which moves over the powder bed the powder is evened out and slightly precompressed. The dimensions of the work space are $x, y, z = 400 * 400 * 500$ mm. The mold is produced in the DSPC-1 machine in layers. A print head, basically similar to the known design of inkjet printers (speed < 1.6 m/s), injects jellylike silica (colloidal silicium compounds, silica gel) into all contours areas that are to have firm consistency later. The affected powder particles are thereby compounded with one another as well as with the preceding layer. After each layer the piston of the build chamber is lowered by one layer thickness and the next layer is added. The cycle is repeated until the complete mold is finished. It is pre-sintered in the machine and then taken out of the powder bed. The surplus powder is removed with a brush.
- **Material/build time/Accuracy:** any pourable material can be used including, for example, titanium and inconel. A disadvantage is that internal area, that is the surfaces of the molds are hardly accessible after the mold is finished and therefore they cannot be appropriately finished. Very thin walls down to 0.2 mm thickness can be realized. Accuracy up to ± 0.05 mm are achieved, thereby meeting the casting tolerances GT9 to GT12. In contrast to casting from stereolithography and laser sintering models which, in principles, allow only one casting per model, the DSPC process is significantly faster. Its greater economical advantage is seen on those solitary occasions when only a few model prototypes are needed.
- **Post-processing:** the further procedure is similar to that of classical precision casting process. The mold is backed (sintered). Afterwards surplus powder that is not firmly attached can finally be removed. In the last step the mold is filled with liquid metal. After this has cool down the ceramic mold is destroyed and the model is removed. The surface may be polished if possible.

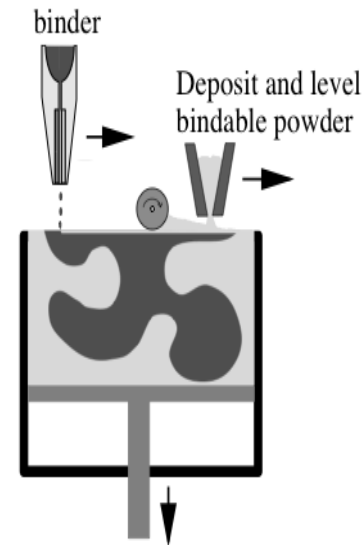

a. Three Dimensional Printing
MIT, and Soligen, Inc. (U.S.)

How to use inkjet printer for life sciences

BIOMEDICAL APPLICATIONS

+ Typing “inkjet” on Pubmed...



- Number of papers: 502

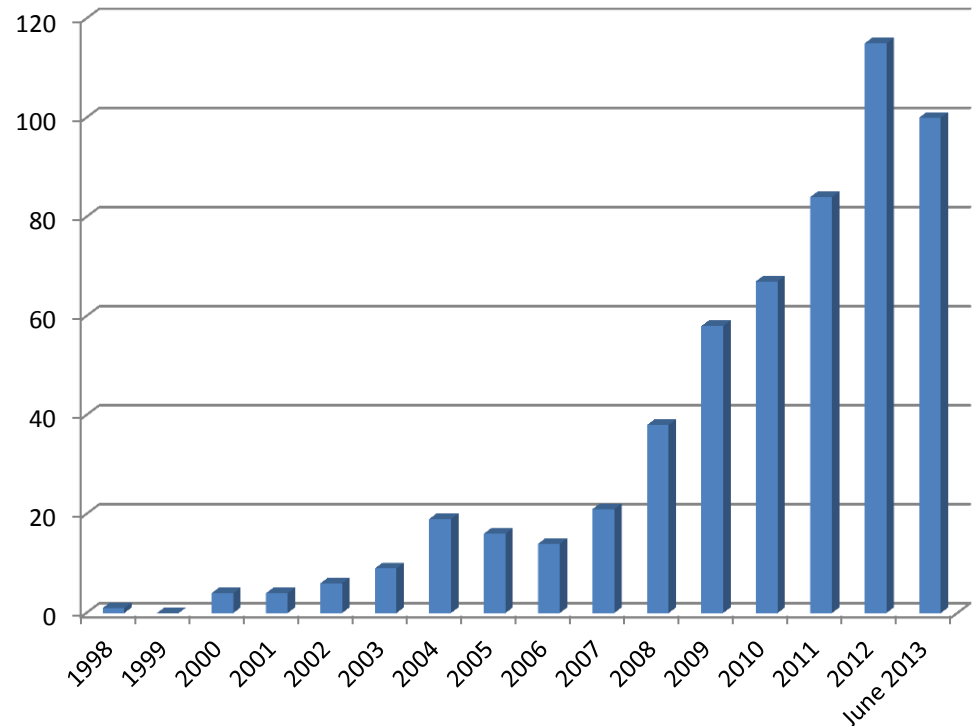
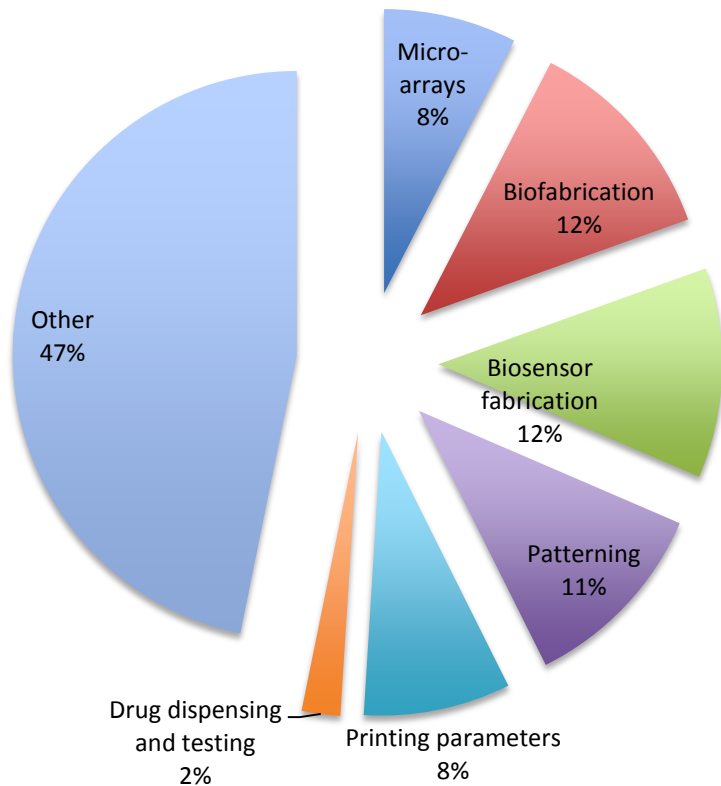

+ Micropatterning and Microarray

- Micropatterning of biological material, such as nucleic acid (cDNA) and proteins, to surface functionalisation (genomic analysis, cell testing, ...).

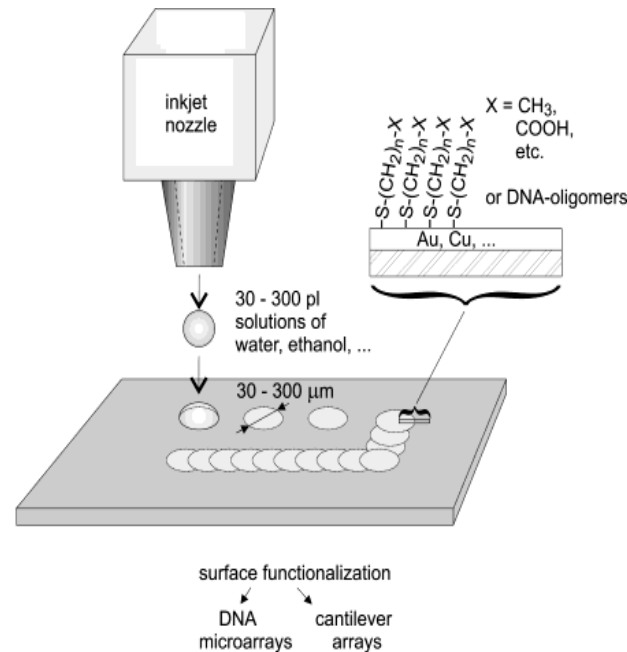

+ Protein-based & particle-based ink

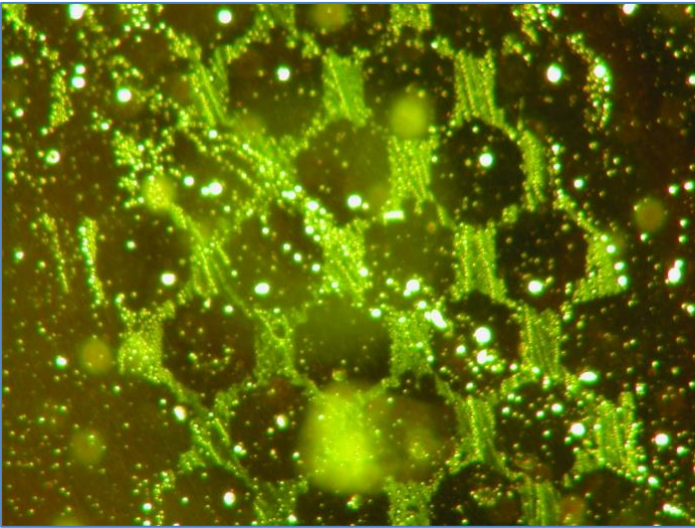

Hexagons on functionalised EDC/NHS glass slide

- side $400\ \mu\text{m}$ - 5 pixel
- line width $160\ \mu\text{m}$ - 2 pixel

- ⦿ Cherub
(University of Pisa logo)

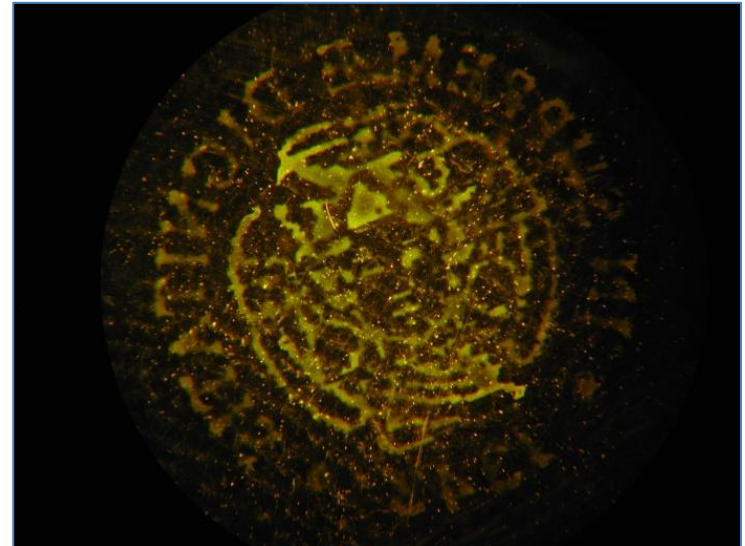

+ Bioprinting

- Computer-aided transfer processes for patterning and assembling living and non-living materials with a prescribed 2D or 3D organization in order to produce bio-engineered structures serving in:
 - basic cell biology studies
 - pharmacokinetic
 - regenerative medicine

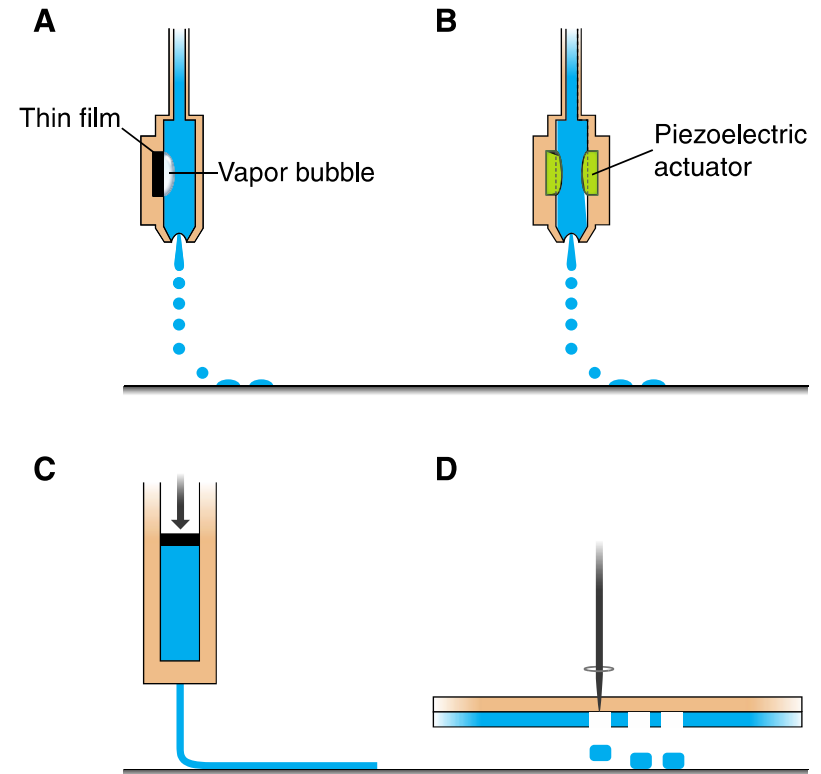

+ Printing biomaterials

- Oxidate alginate 10% in Borax (0.1M) (very low viscosity – 4 cP)
- Gelatin (type A) 15% in Borax (0.1M)
- Cartridge temp.: 30 °C
- Plate temp.: 37 °C

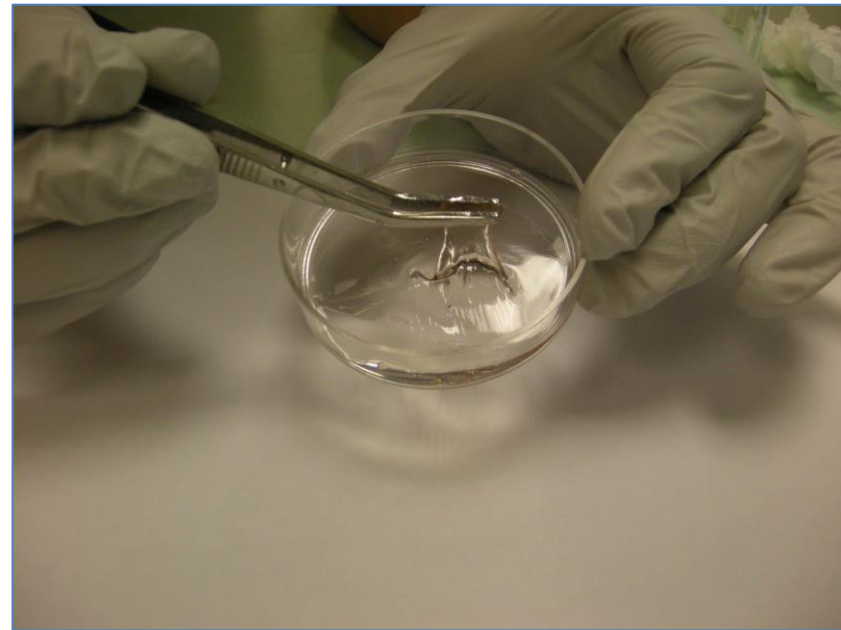
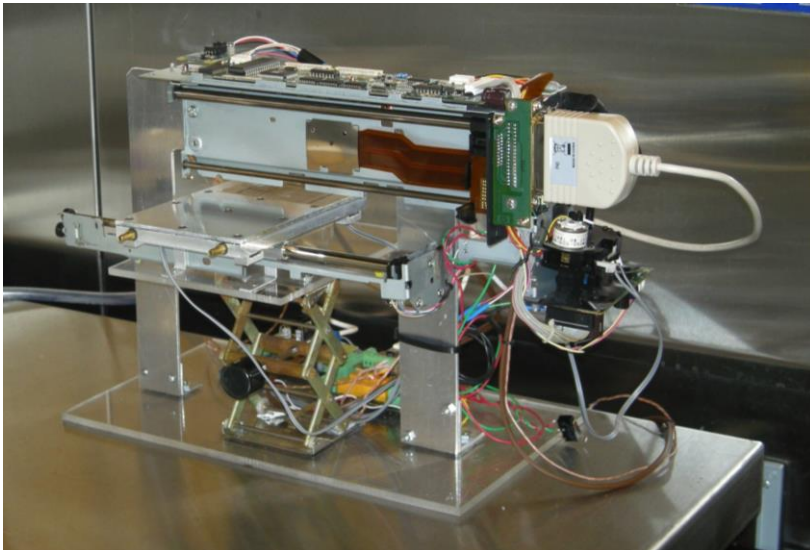

+ Cell printing

- Typing “inkjet” on PubMed...
- 45 papers are focused on cell printing until June 2013

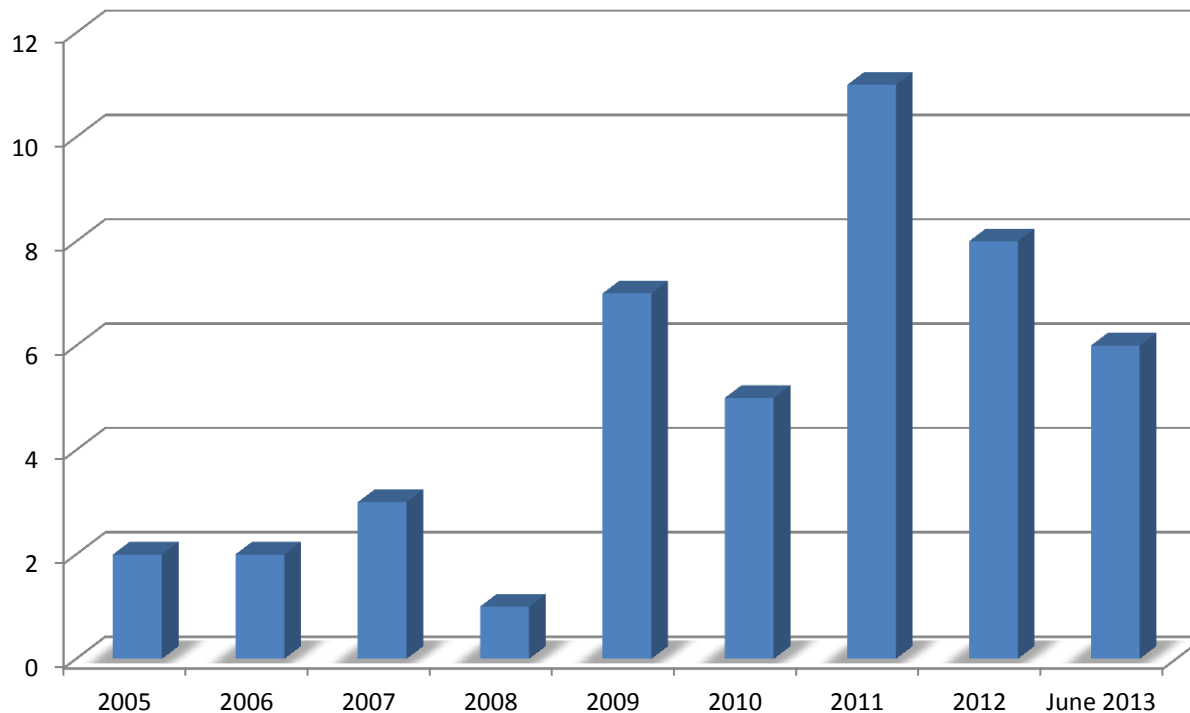

+ Cell printing

- Thermal IJP

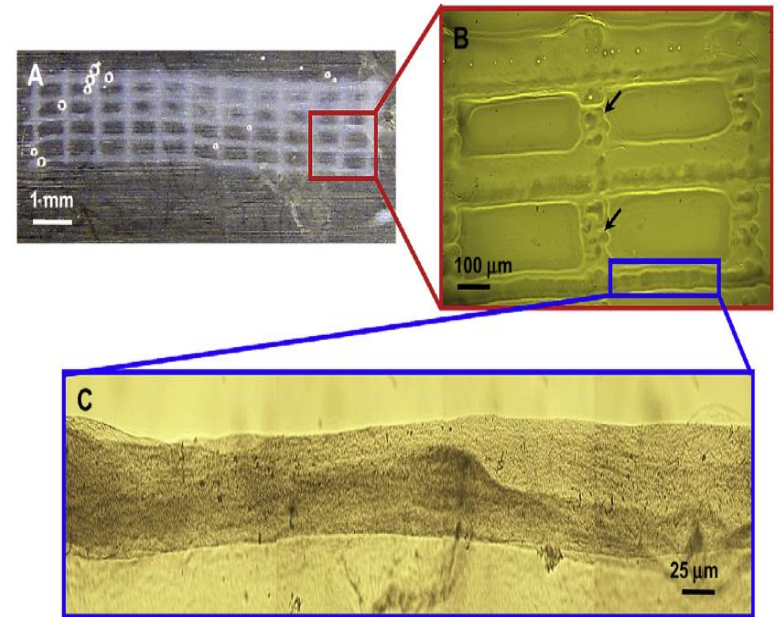
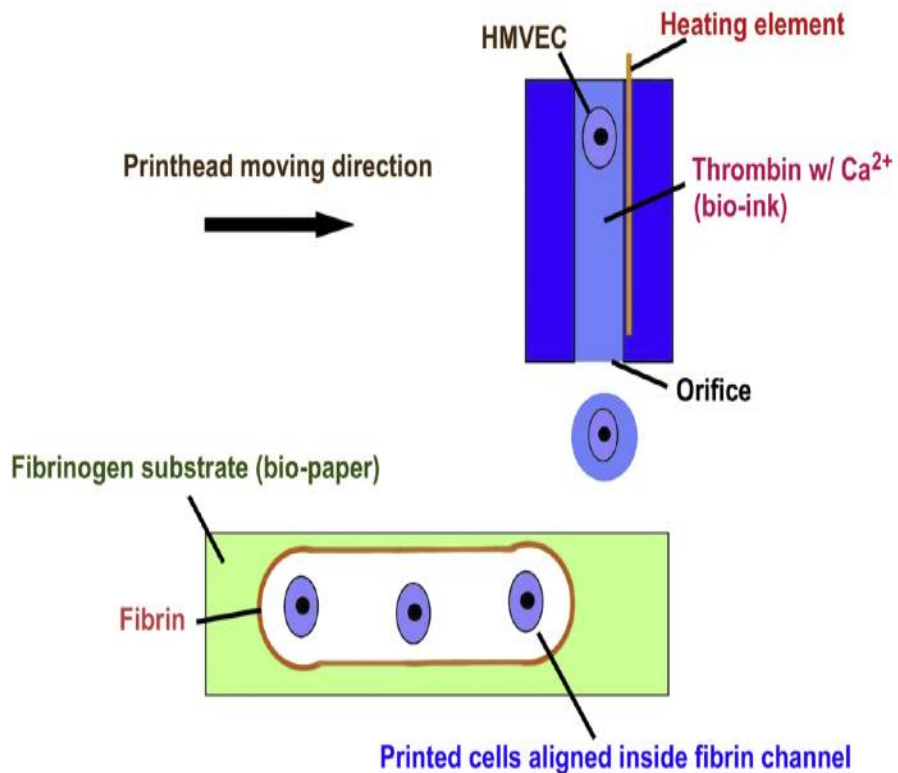

+ Cell Printing

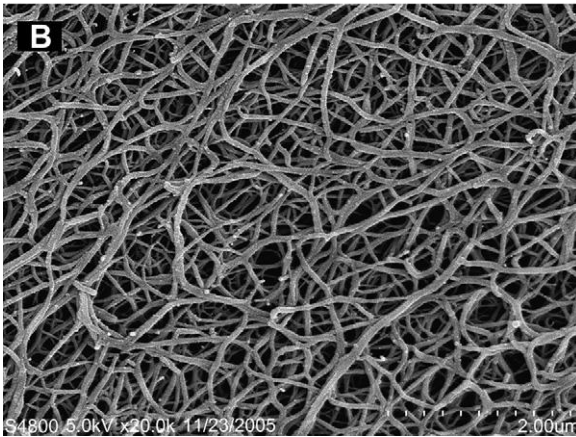
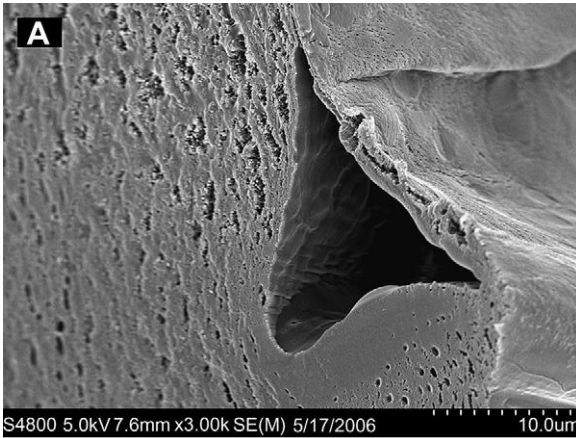

+ Cell Printing

- Thermal IJP

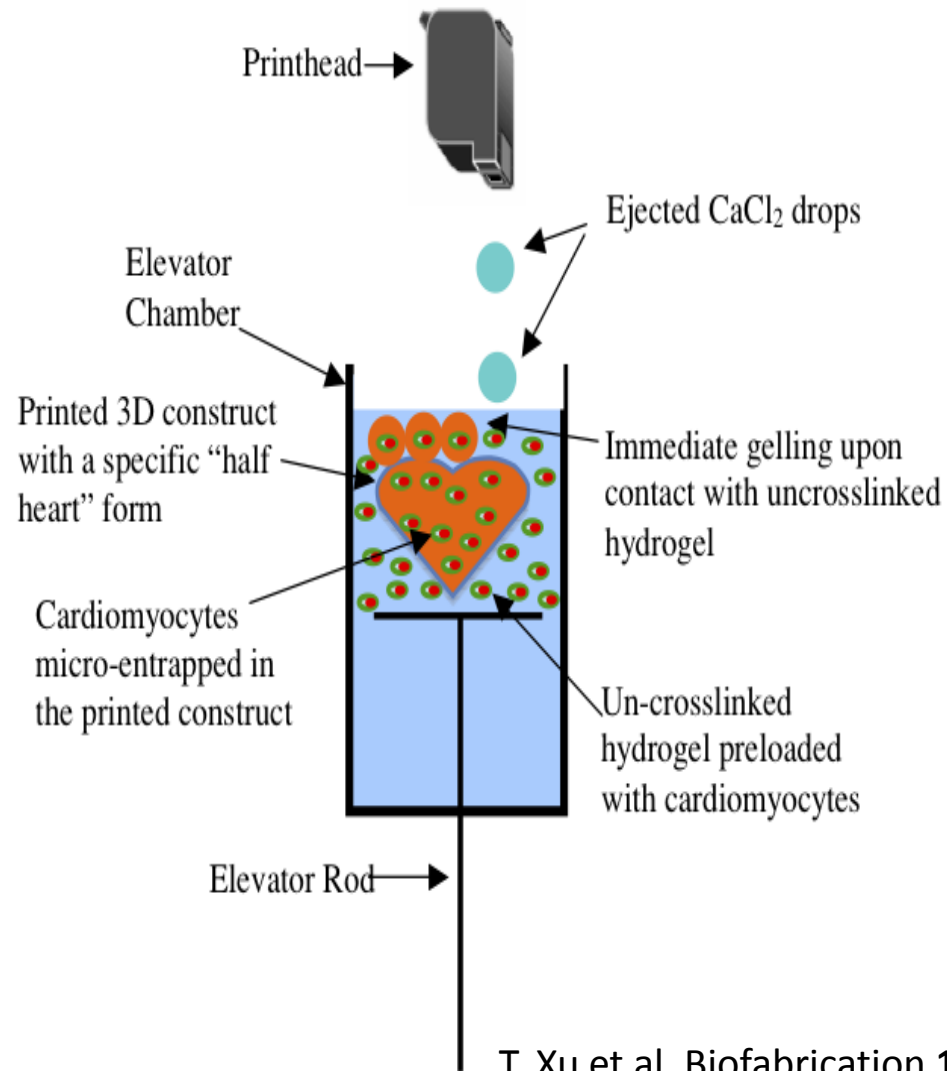
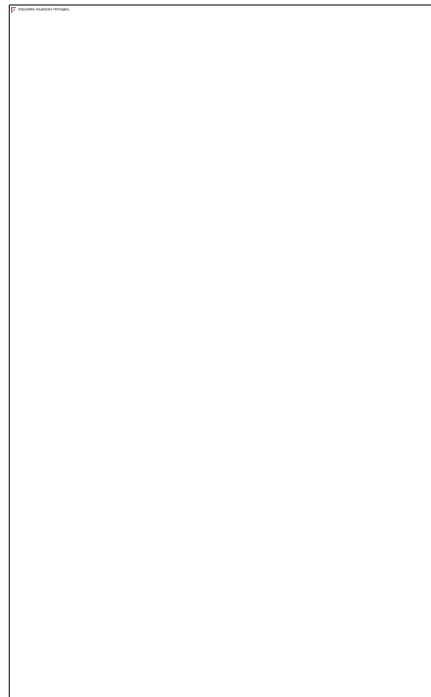

+ Cell Printing

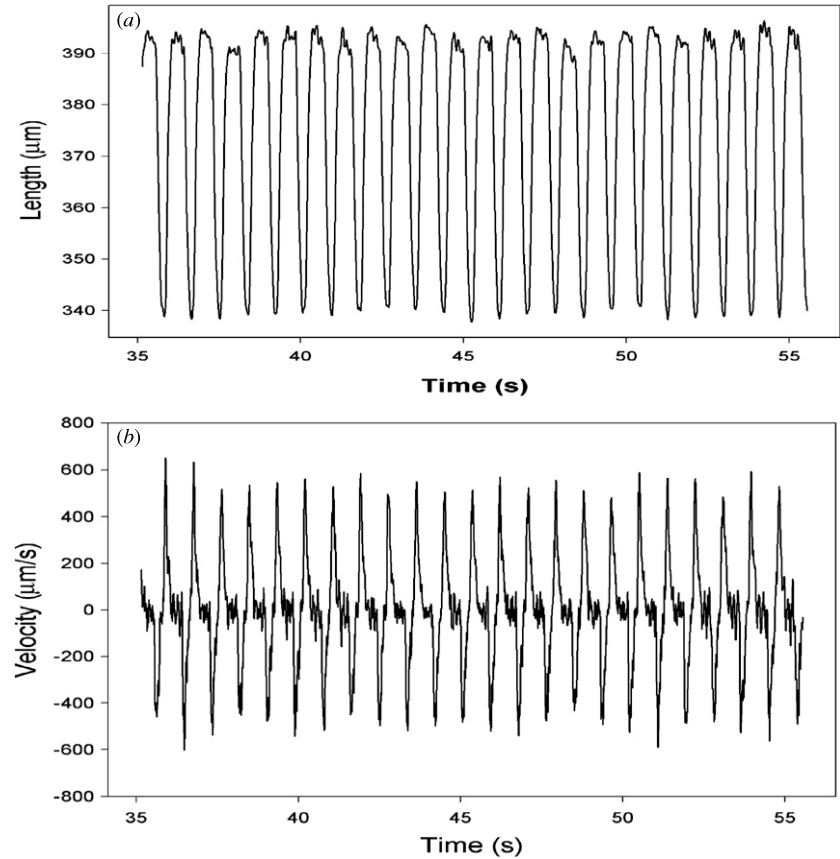
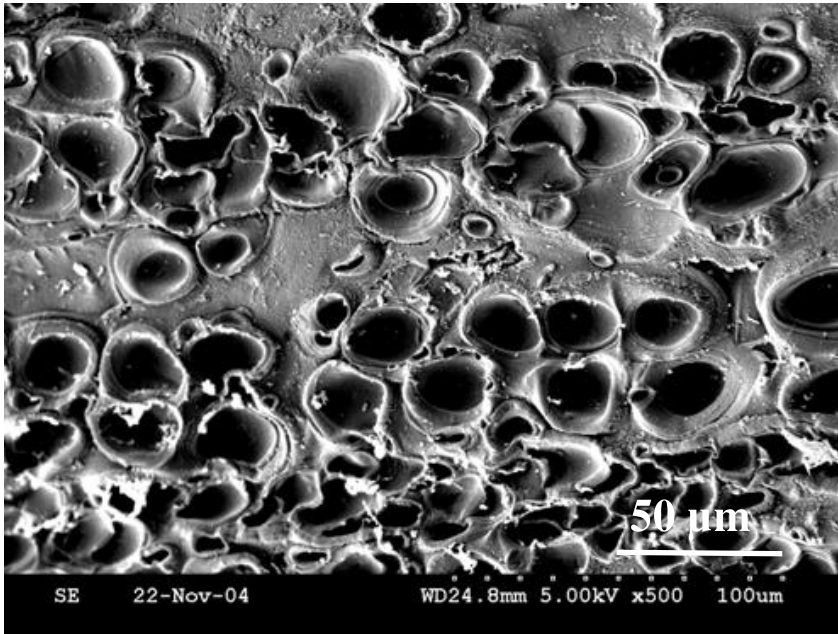

+ Cell printing

- Piezo IJP
 - Ink: 0.8 w/v sodium alginate + 6×10^6 Cell/mL (HeLa)
 - Substrate: 2% calcium chloride + 20% w/v PVA + 3% hyaluronic acid

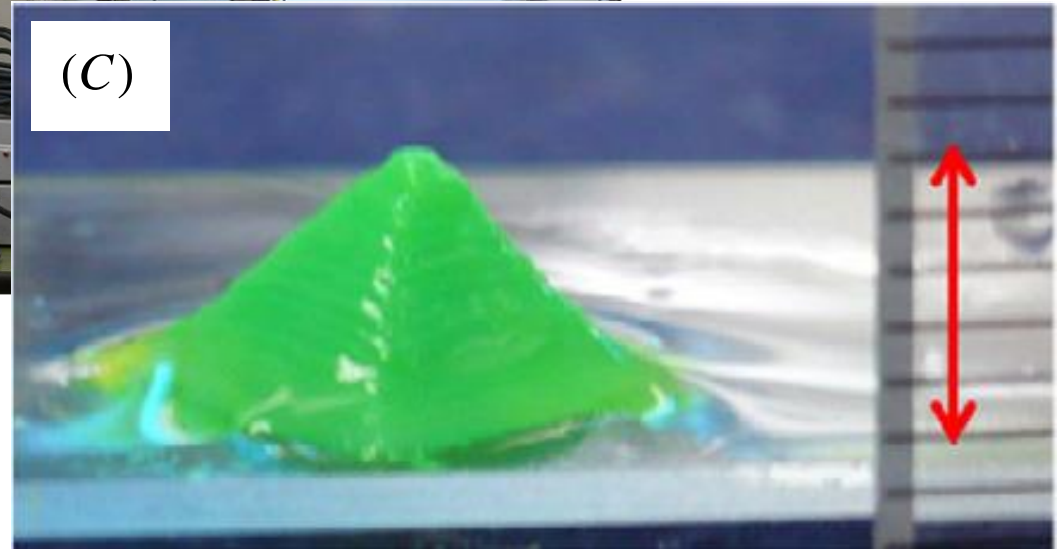
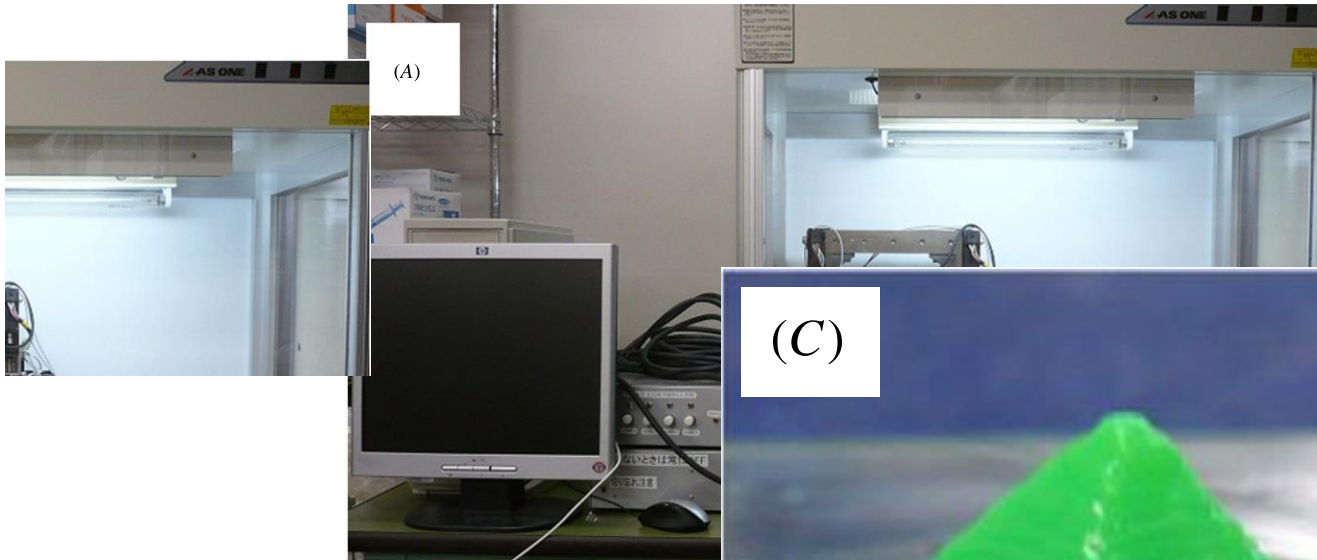

+ Indirect Rapid Prototyping



Casted Materials	Extraction method	Resolution (μm)
HA, TCP	Pyrolysis	300-400
Collagen, Silk, PLLA	Organic Solvent	200-400

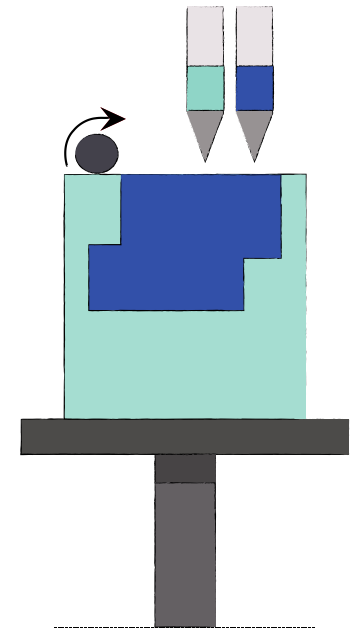
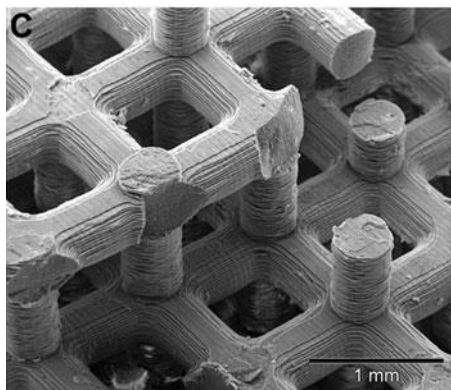
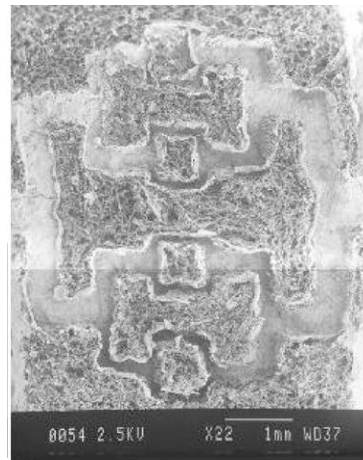

E Sachlos et al., *Biomaterials*, 24(8):1487– 97, Apr 2003

MJJ Liu et al., *Med Eng Phys*, Nov 2011

M Schumacher et al., *J Mater Sci: Mater Med*, 21(12):3119–3127, Dec 2010

JM Taboas et al., *Biomaterials*, 24(1):181 – 194, 2003

+ Indirect Rapid Prototyping

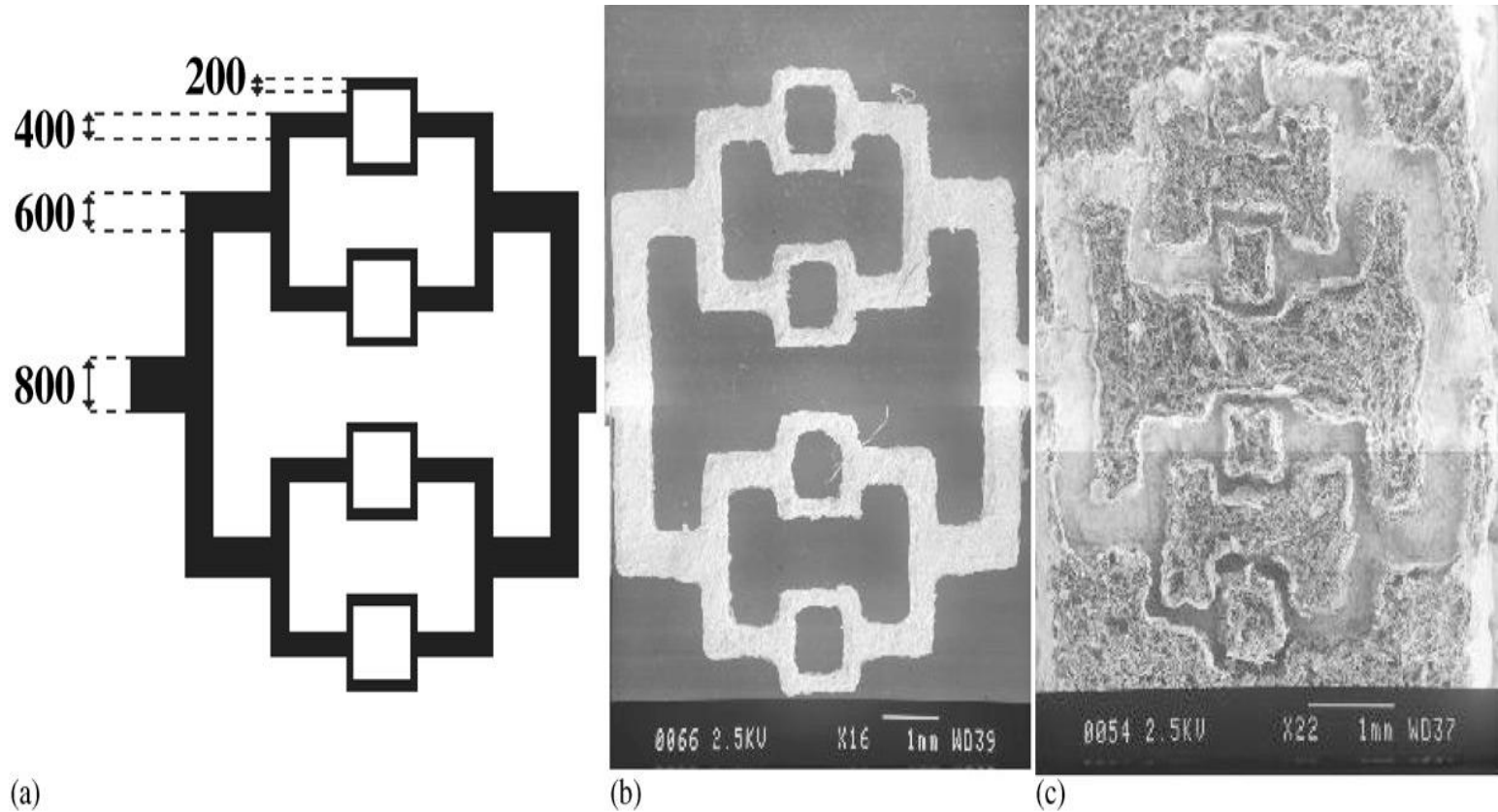

Analysis of possible damages on biomolecules and cells

EFFECTS ON PRINTED BIO-MATERIALS

+ Stress and forces on living ink

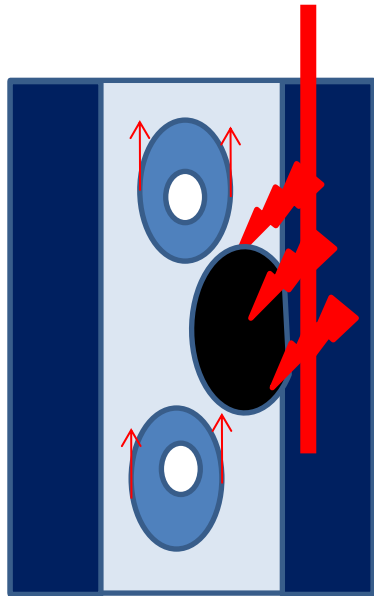

Stress inside the cartridge:

- Thermal
- Mechanical

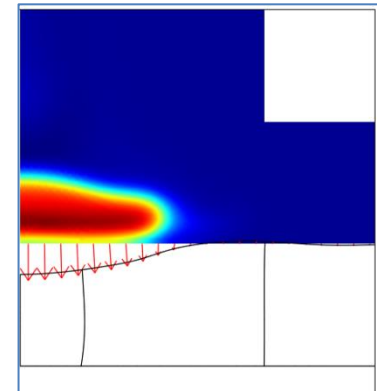

Impact on the substrate

+ Effects on cells

- Piezo IJP

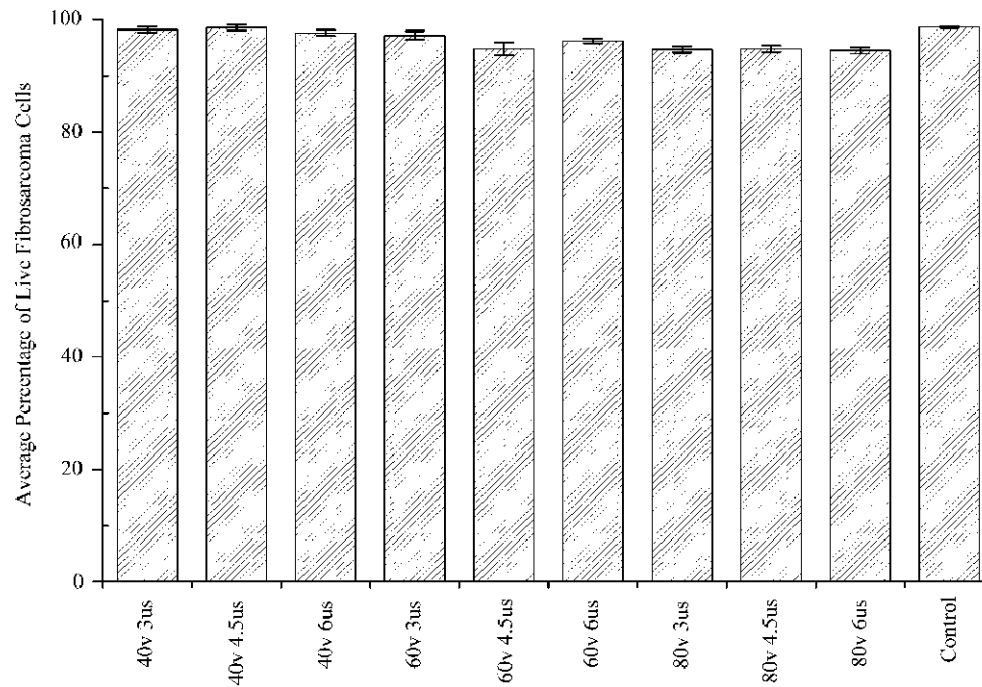

+ Effects on cells

- Piezo IJP

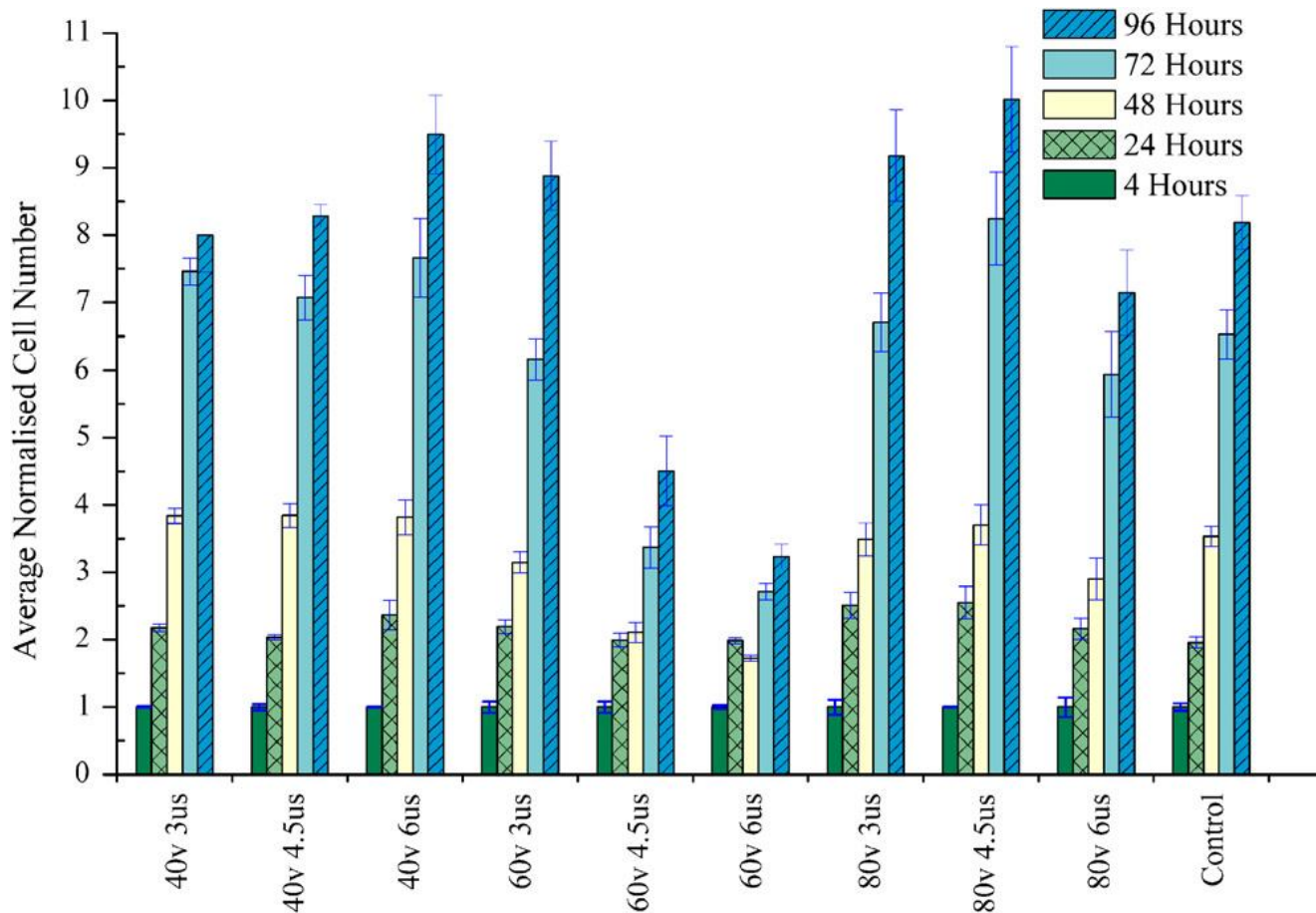

+ Effects on cells: vitality and apoptosis

- Thermal IJP

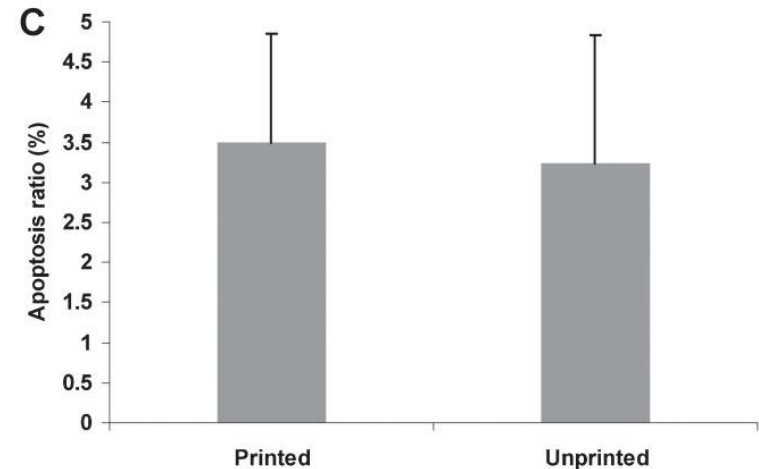
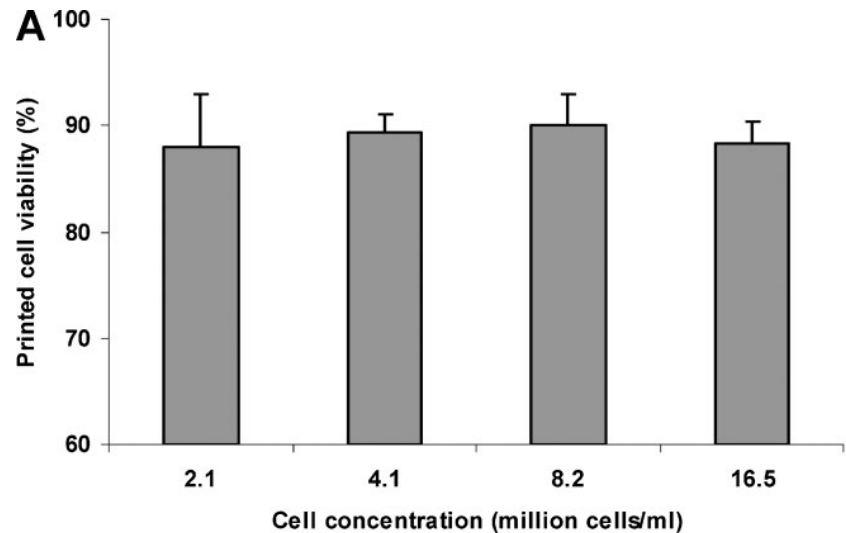

CHO cell printed onto collagen type I solution 2mg/ml

+ Effects on cells: membrane damages

- Pores on cell membranes
- Small pores may be created during printing
- After two hours cells recover
- Exploit this phenomenon to gene delivery

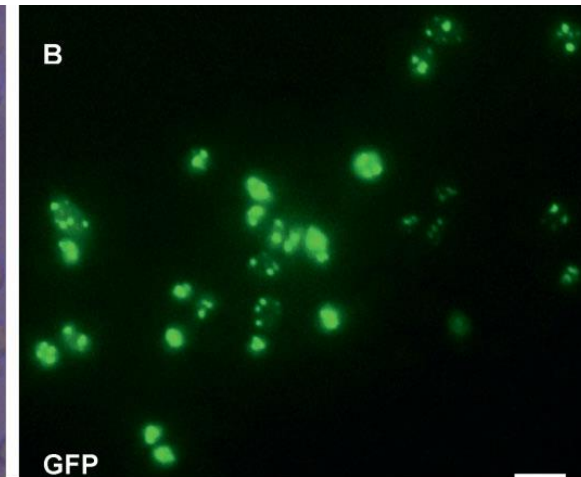
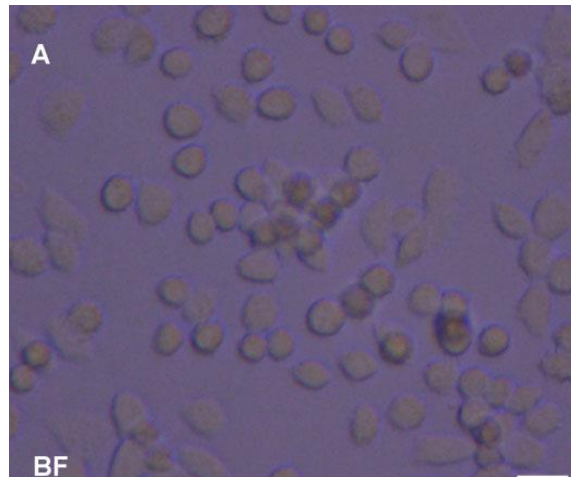
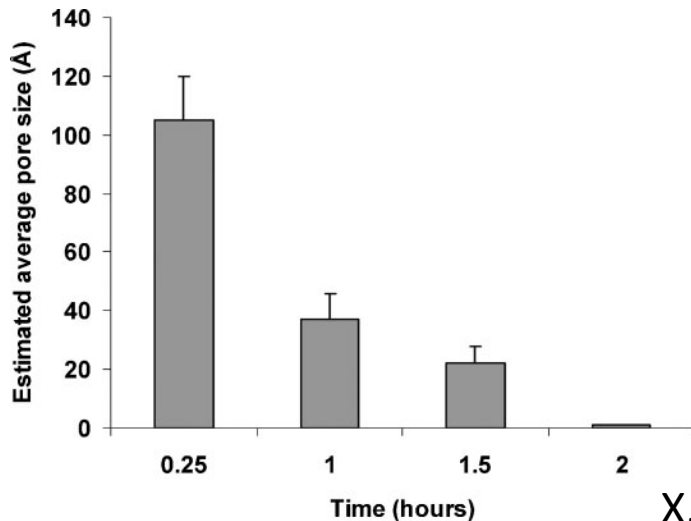

+ Fluid-mechanics of drop impact

- The fluid flow associated with impinging drops is rather complicated and not understood in detail. It depends on several parameters:
 - Viscosity
 - Surface Tension
 - Geometry of substrate
 - Mechanical properties of substrate

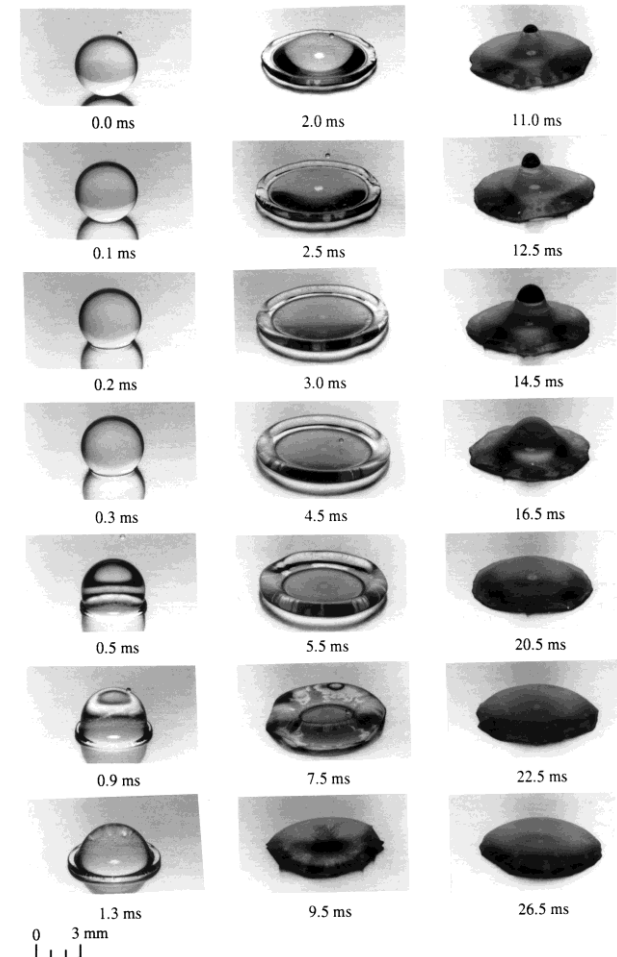

+ Living-ink preparation

- Fibroblasts 3T3 (mouse embryonic fibroblast cell line) suspension of $5 \cdot 10^6$ cells/ml
- Four different surfaces as printing substrate.
 - polystyrene (PS multiwell plates, rigid substrate);
 - medium with serum (liquid substrate);
 - medium with 1% w/v of gelatin (viscous substrate);
 - 3 mg/ml collagen cross-linked with M199 10X culture medium (visco-elastic substrate)
- Printed with a TIJ – Olivetti Biojet

+ Living ink results

- CellTiter-Blue Cell Viability Assay (Promega, Madison, WI)

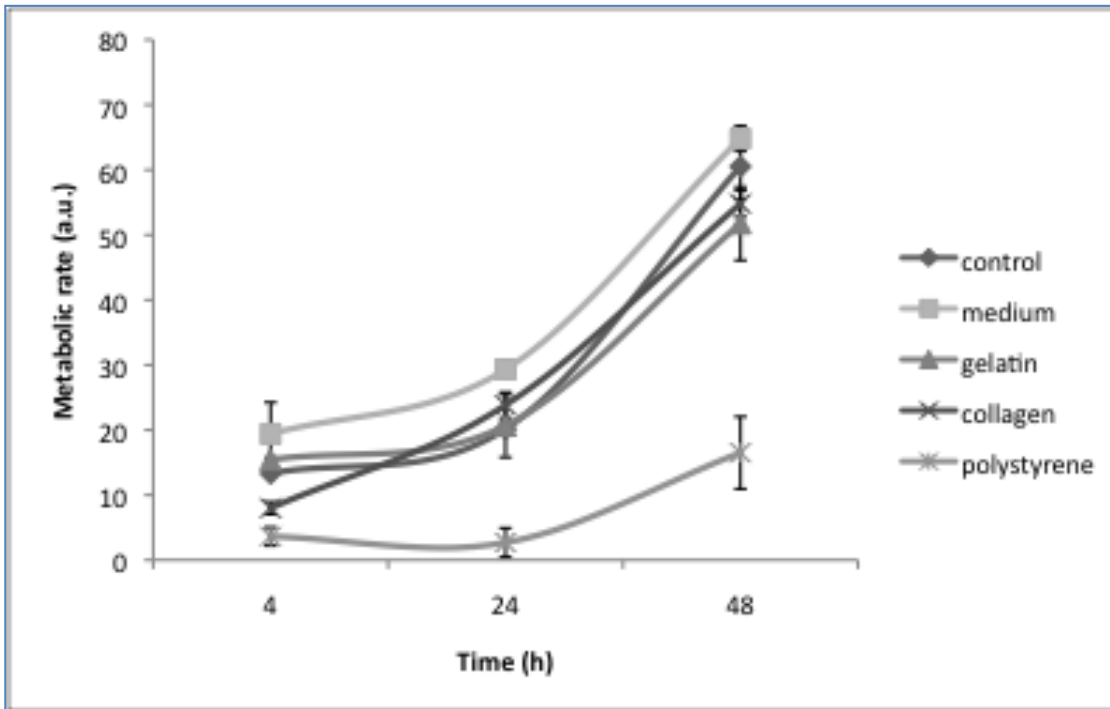

A stiff surface generates an elevated number of died cells. A very small part of cells survive at the process and, after 48 hours, they start to reproduce. For the other substrates there are not so remarkable differences.

+ Living ink results

- relationship between viability and mechanical properties of substrates

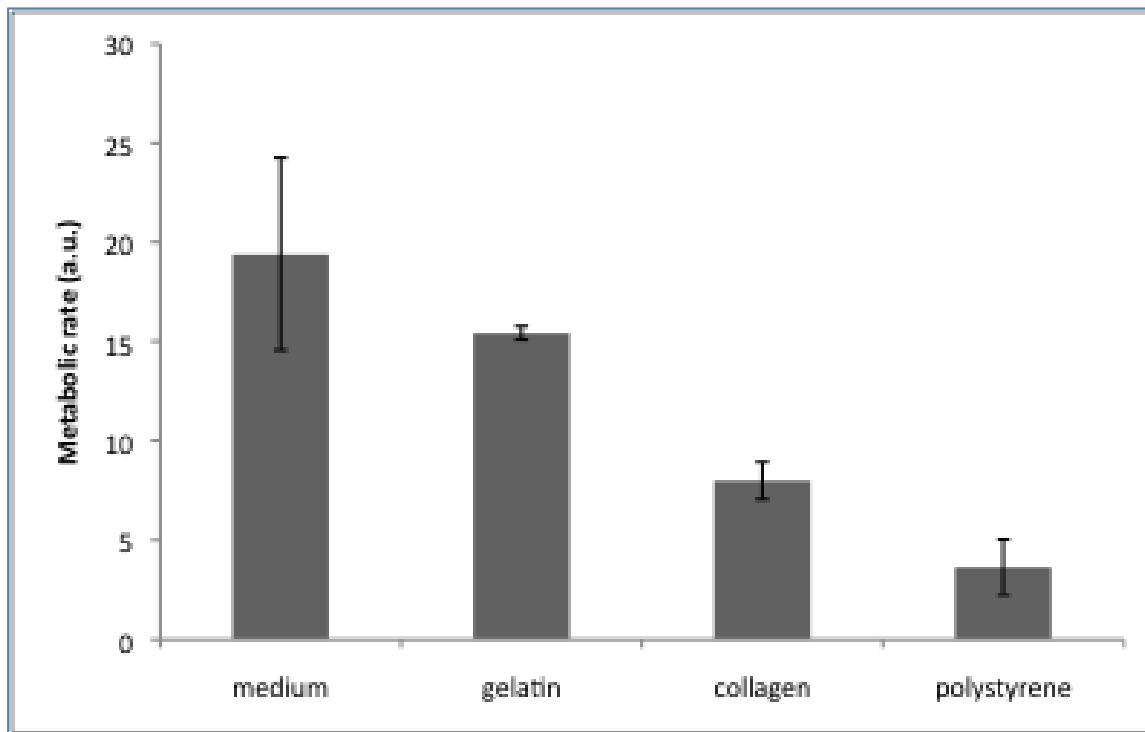

+ FEM model of drop impact

- Phase field method:
 - Track a diffuse interface separating two phases
- Navier-Stokes equations
 - Transport of mass and momentum
- Structural mechanics equations
 - Interaction fluid-substrate

+ FEM model of drop impact

- FEM geometry

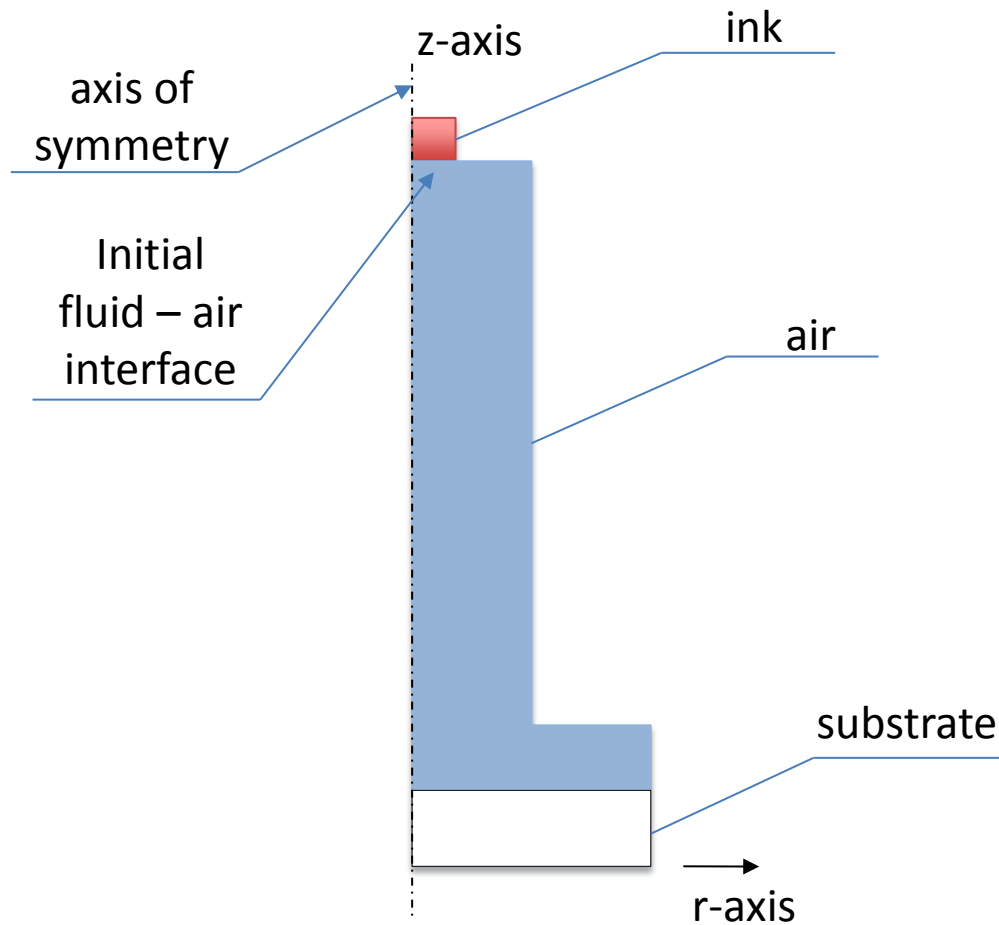

+ FEM Results

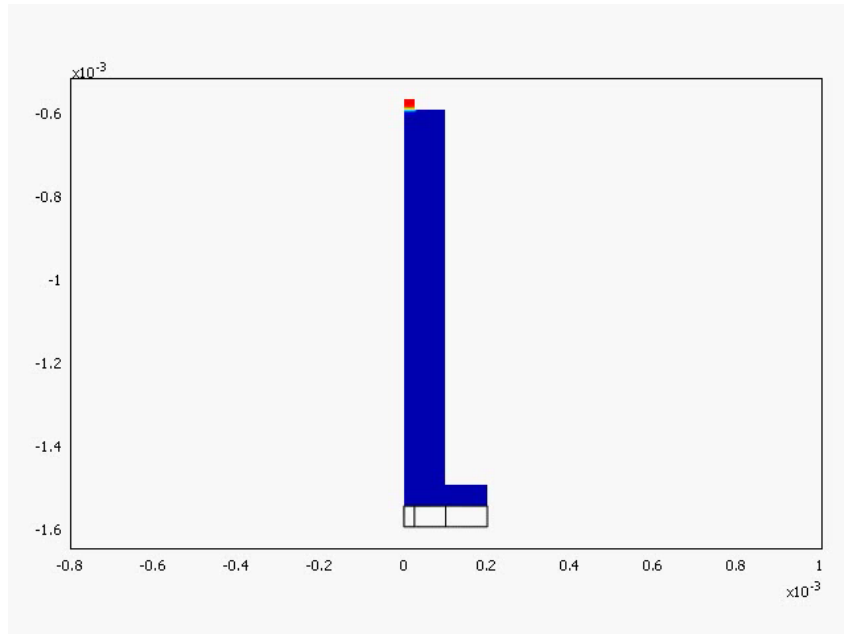

⦿ Drop flight

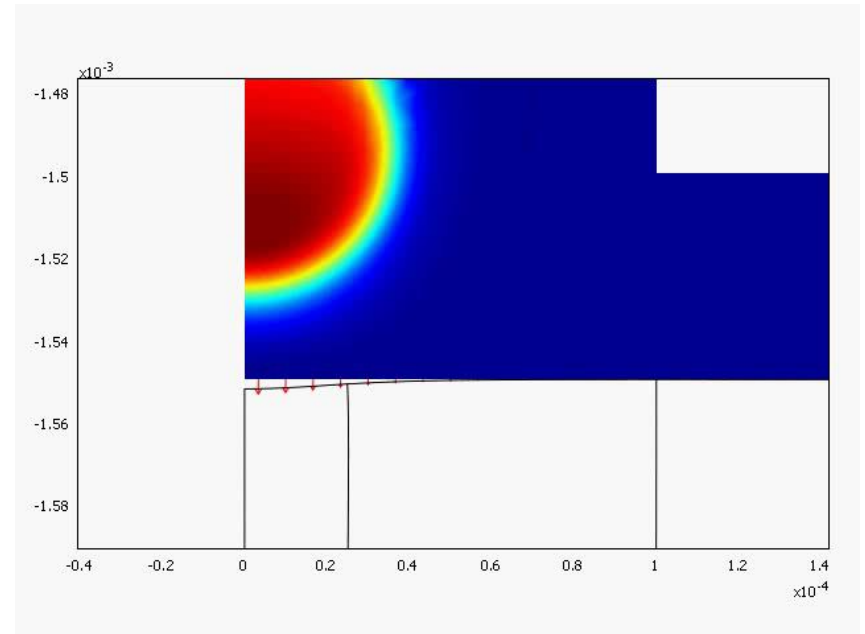

⦿ Drop impact

+ Effect of substrate on drop shape

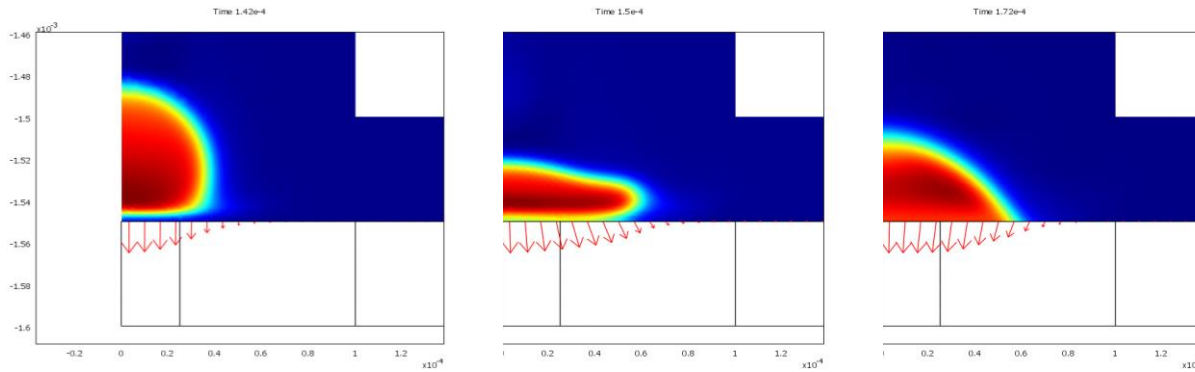

Hard
(5 GPa)

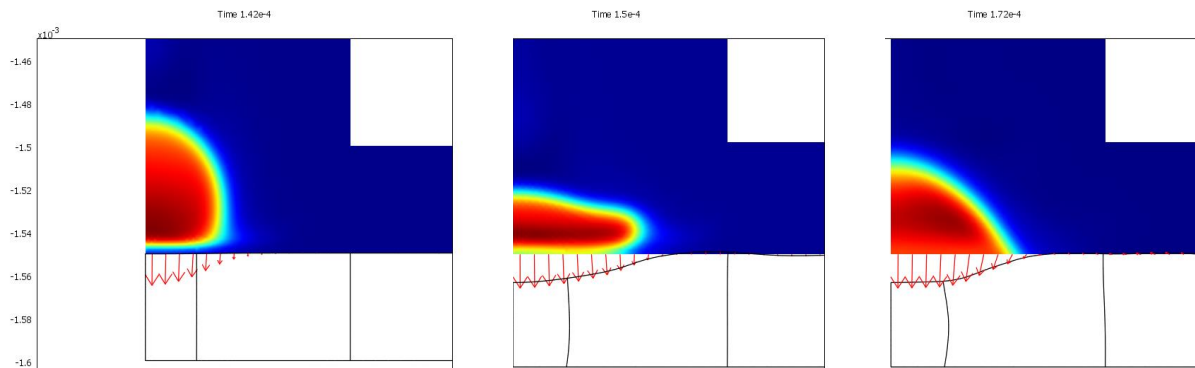

Medium
(5 MPa)

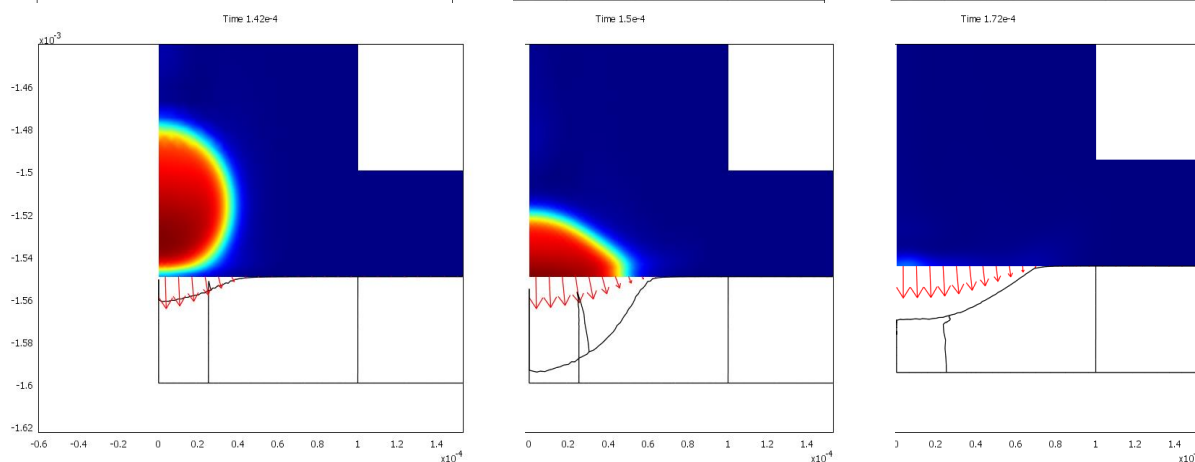

Soft
(5 kPa)

+ Effect of substrate rigidity on absorbed energy

- ⦿ Absorbed energy in time

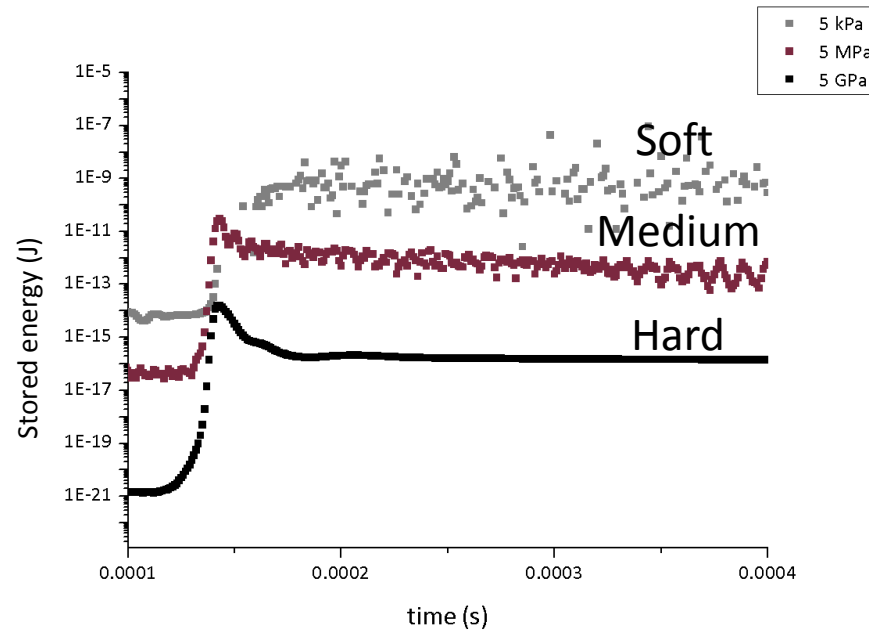

- Energy stored in the droplet during the landing phase is transmitted to the substrate: low values of dissipation energy mean high forces acting on the droplet, while high dissipation energy values correspond to low forces inside the droplet.

+ Effect of substrate rigidity on absorbed energy

⦿ Maximum of absorbed energy

- relationship between absorbed energy and mechanical properties of substrates

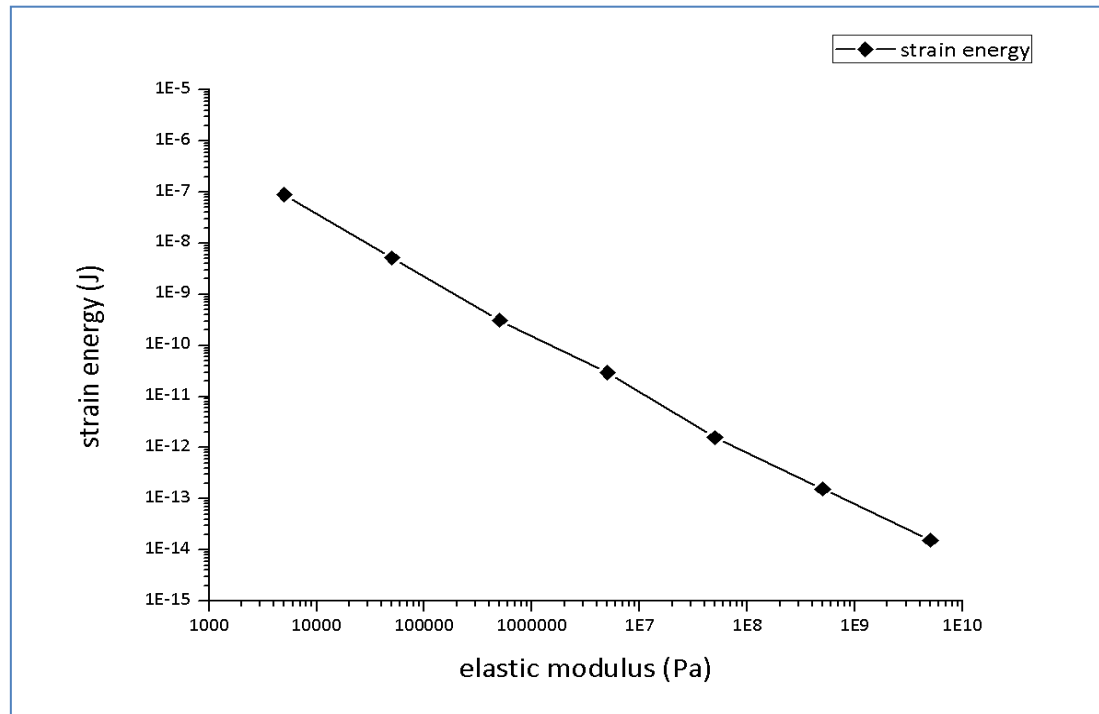

+ FEM-biological results correlation

- Strong correlation substrate stiffness – cells vitality

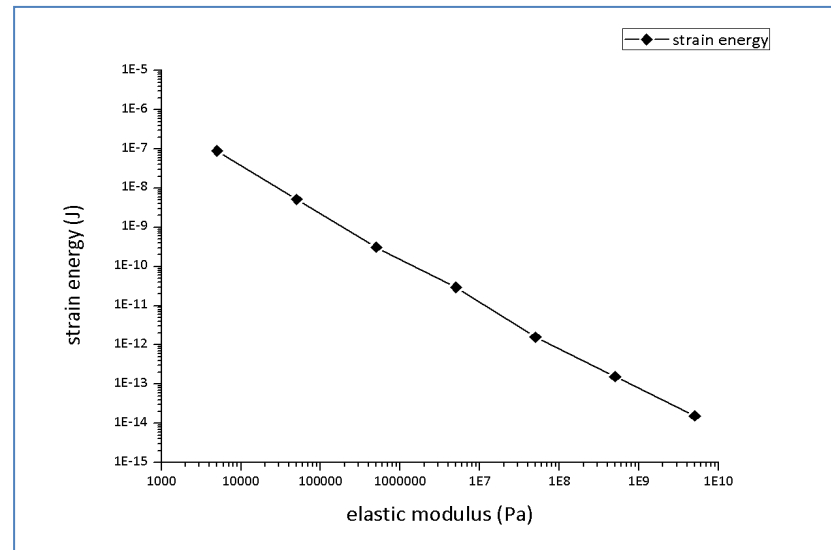
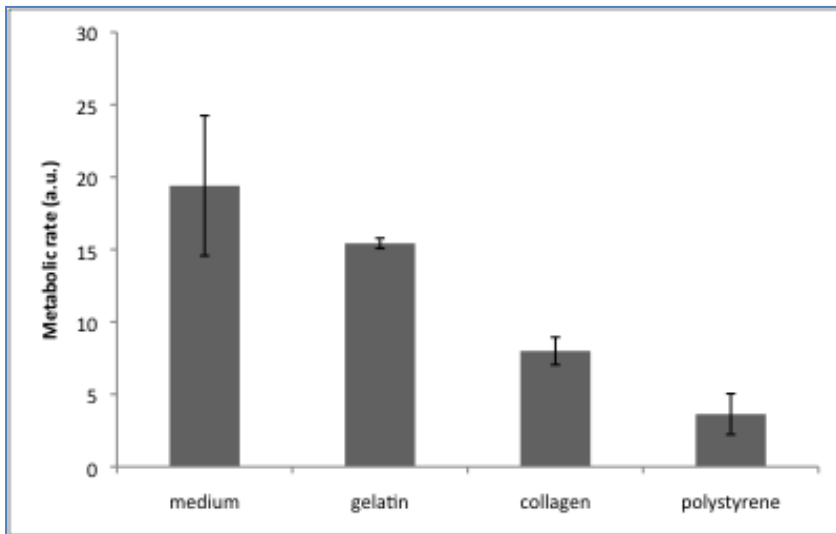

+ FEM-biological results correlation

- Strong correlation substrate stiffness – cells vitality

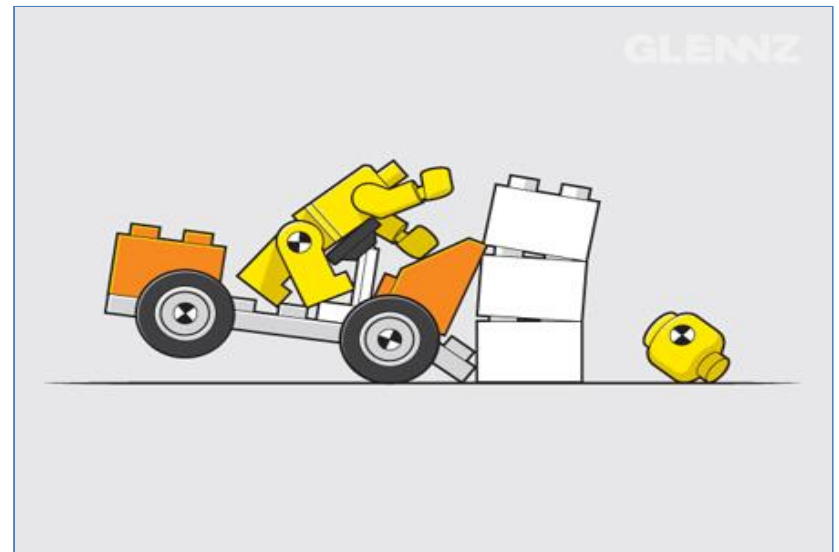
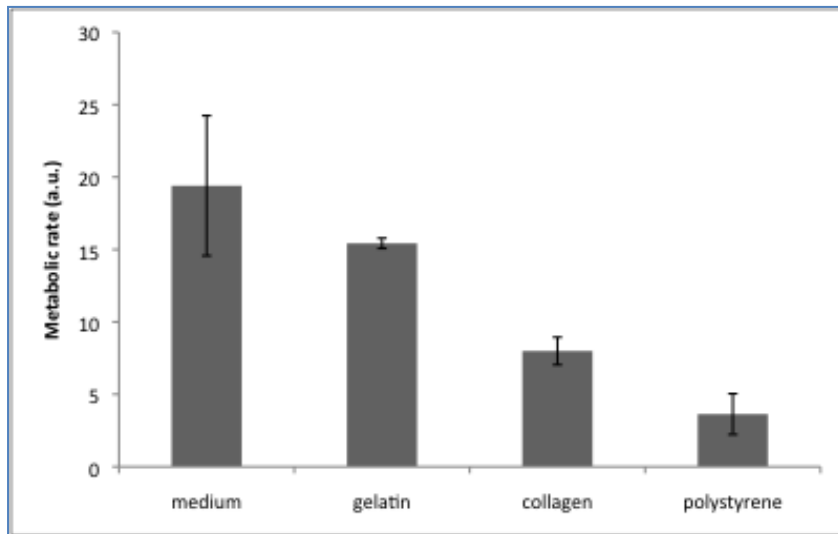

+ Comparison with extrusion based system

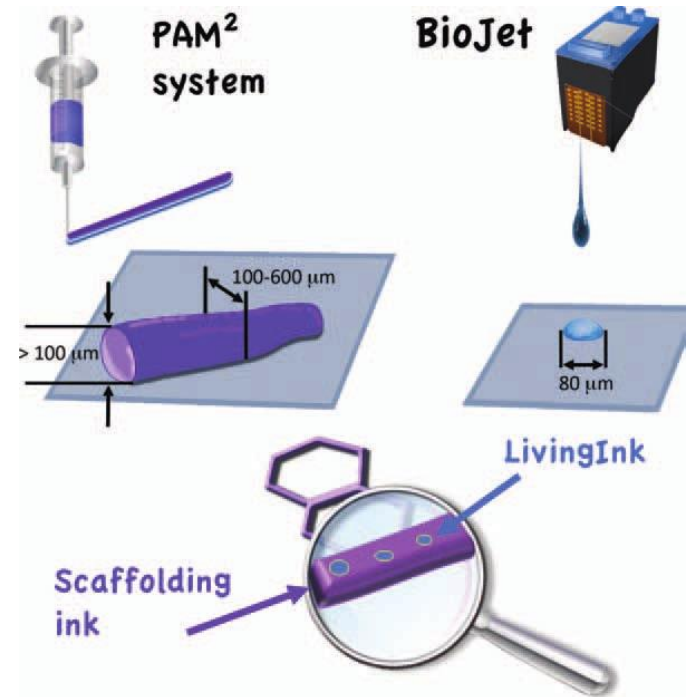
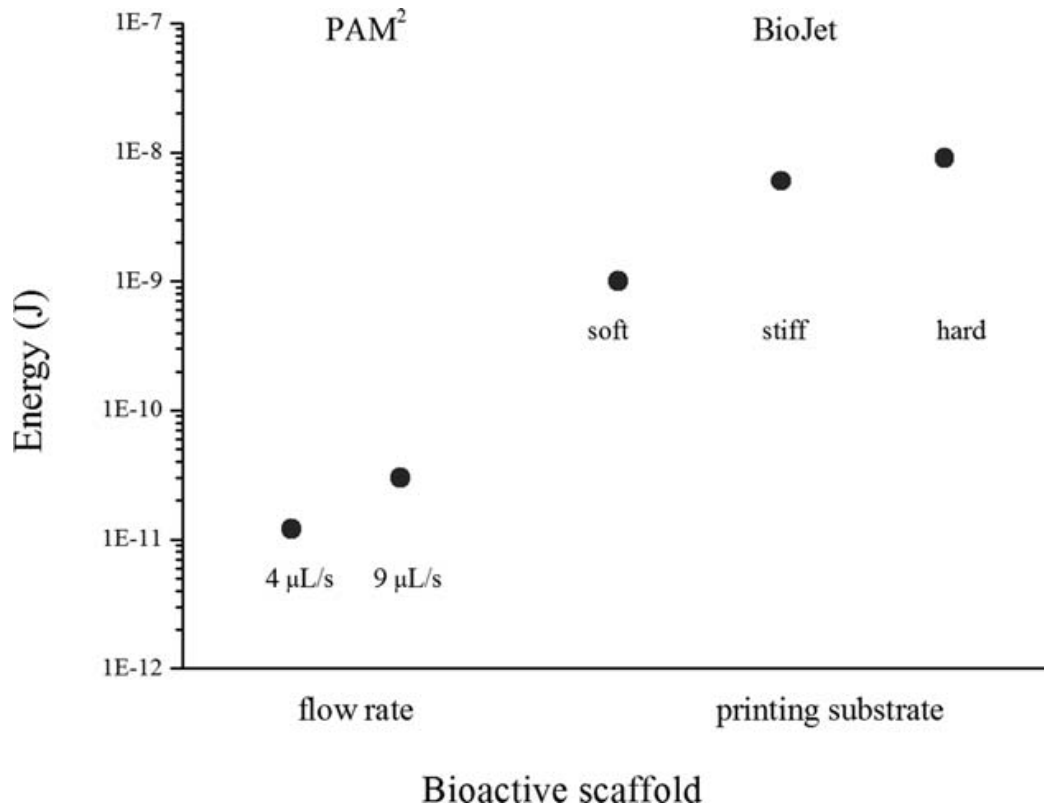

CONCLUDING CONSIDERATIONS ON INKJET PRINTING

+ Inkjet perspectives

- The challenge facing the use of inkjet printing for applications in advanced materials applications is feature resolution.
- The resolution of any printed object is clearly limited by the volume of the ejected drop.
- At present the limiting droplet size is approximately 1 picoliter, or a diameter of $\approx 12 \mu\text{m}$.
- Although smaller liquid droplets can be generated by other technologies (e.g., electrostatic droplet ejection from a Taylor cone), it is unlikely that much smaller droplets will be available from inkjet printheads in the near future because of the limiting physics of the droplet generation process.

+ Inkjet perspectives: combination with other techniques

- Lithographic technology
 - Modify the substraty hydrofilithy

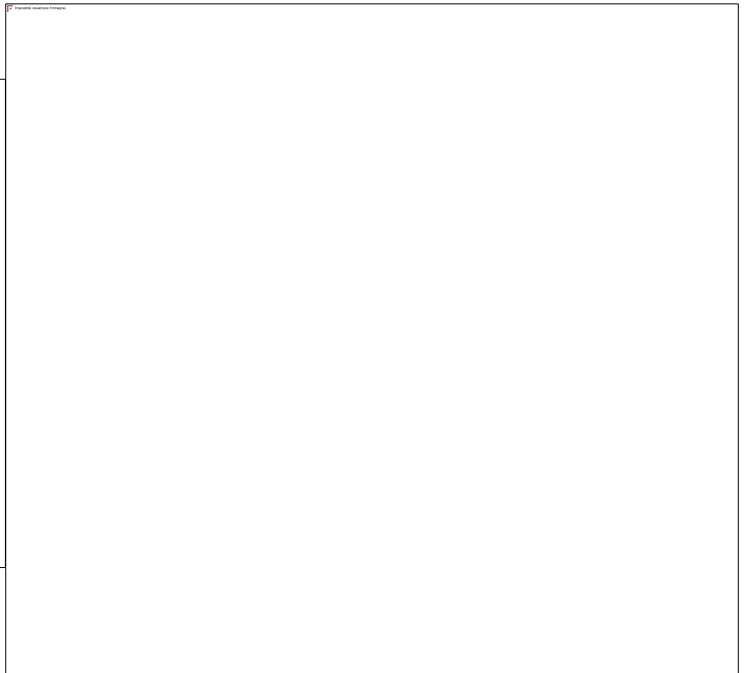
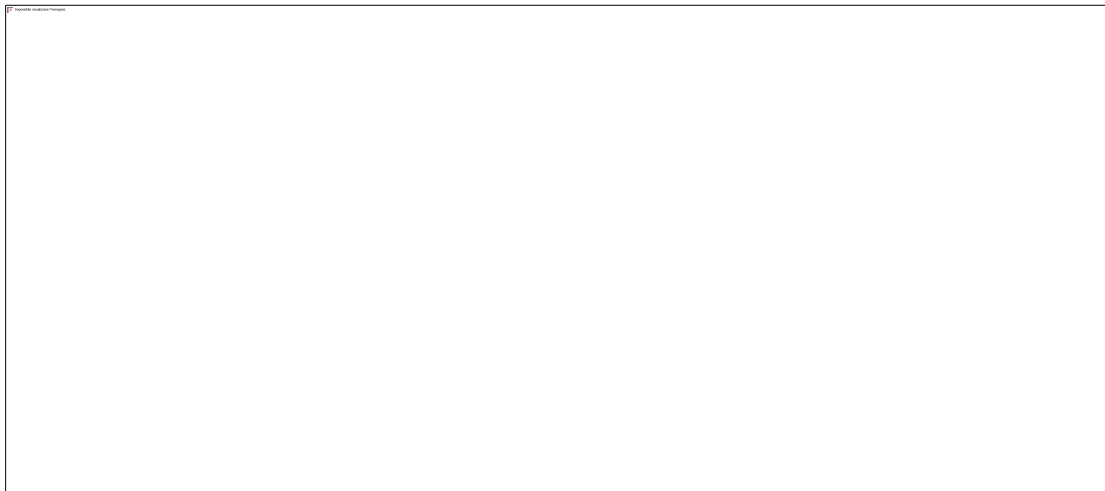

+ Inkjet perspectives: combination with other techniques

- Electrospinning

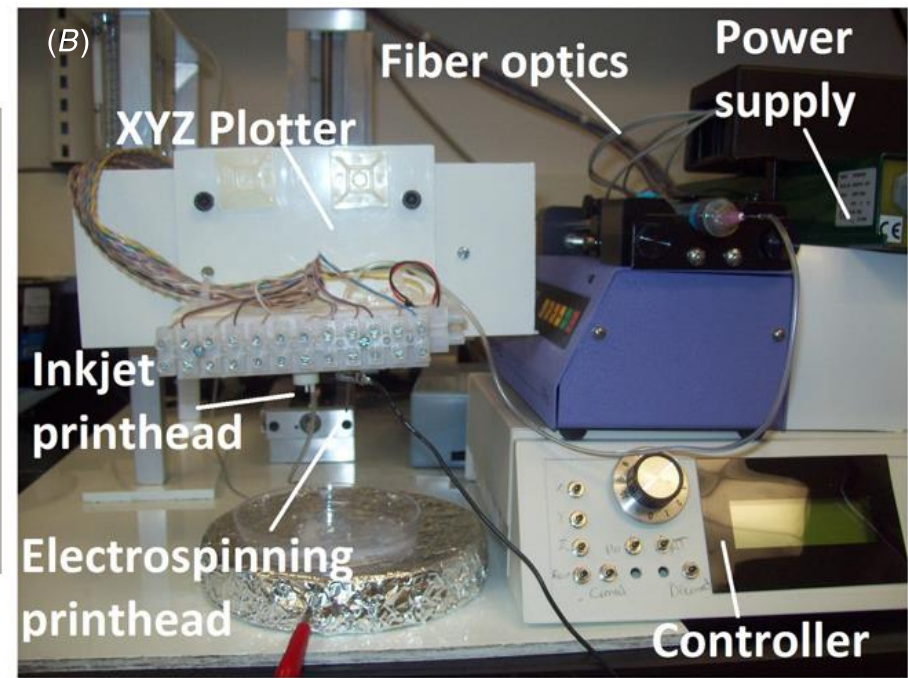
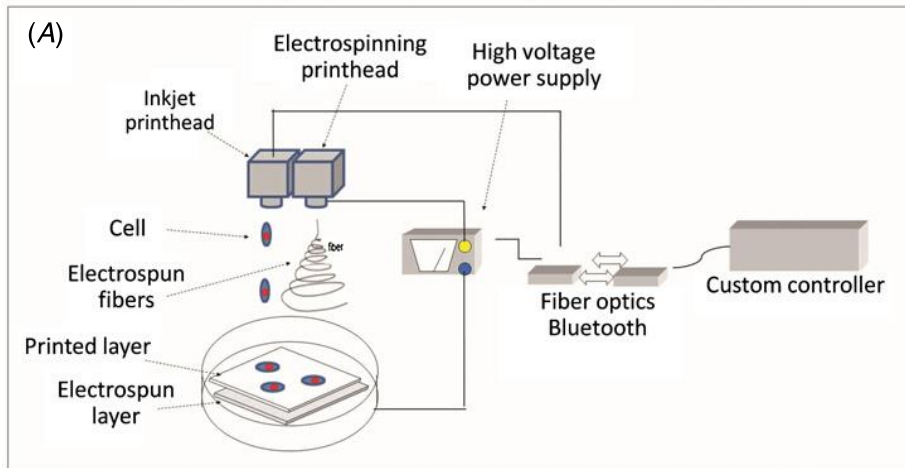

+ Inkjet perspectives: combination with other techniques

- Electrospinning

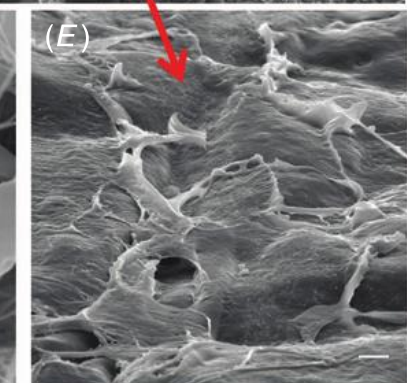
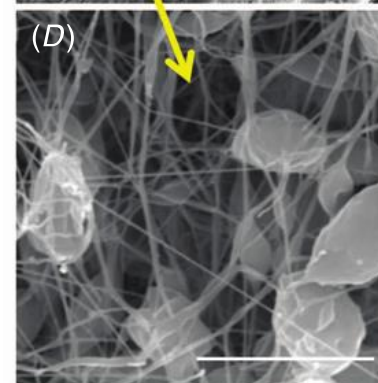
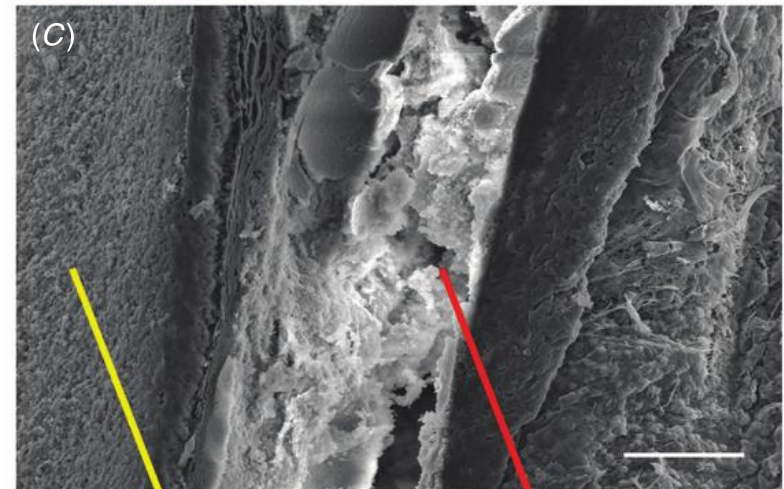
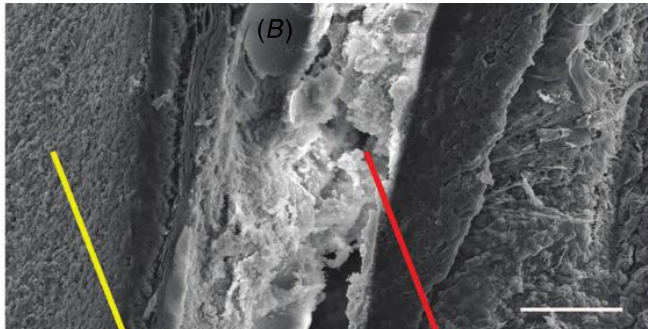

+ Combination of several techniques

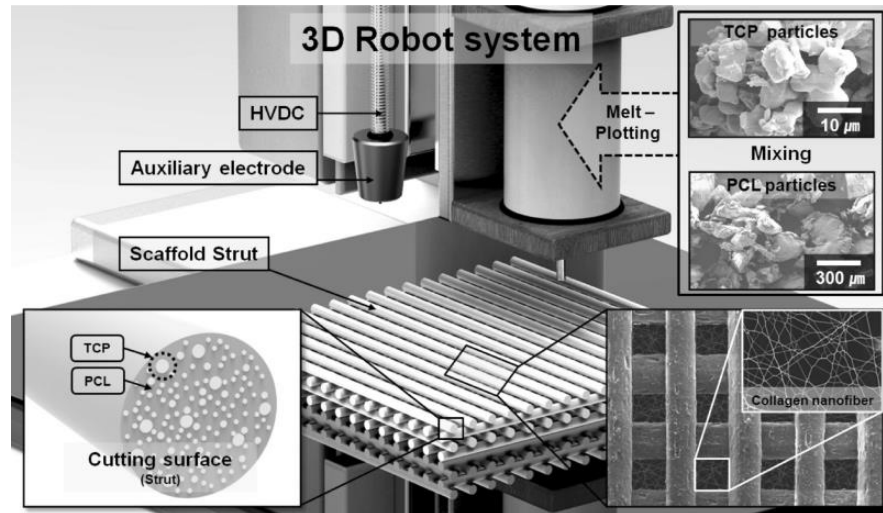

+ Toward a smart scaffold?

- Combination of extrusion based systems, electrospinning, and inkjet printing can potentially combine:
 - Mechanical properties
 - Micro and nano topology
 - Biochemical cues
 - Cell disposition

